



INVERTER 變頻式空調

OPERATION MANUAL

使用說明書

DAIKIN ROOM AIR CONDITIONER
DAIKIN 空調機

MODELS 型號

- FTXV22UVLT
- FTXV28UVLT
- FTXV36UVLT

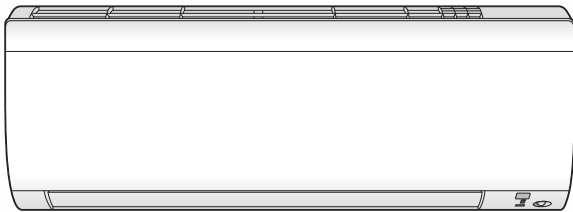

Features

Enhanced comfort and energy savings



INTELLIGENT EYE

The INTELLIGENT EYE sensor detects the human movement in a room. If no one is in the room more than 20 minutes, the operation automatically changes to energy saving operation.

►Page 14



COMFORT AIRFLOW

The airflow direction is upward while in COOL and DRY operation, and downward while HEAT operation. This function prevents cold air or warm air from blowing directly on your body.

►Page 13

Other functions



ECONO

This function enables efficient operation by limiting the maximum power consumption. It is useful when using the air conditioner and other electrical devices simultaneously on a shared electrical circuit. ►Page 17



OUTDOOR UNIT QUIET



OUTDOOR UNIT QUIET operation lowers the noise level of the outdoor unit. This function is useful when you need to consider the noise for your neighbourhood. ►Page 18

Contents







Read Before Operation

Safety Precautions.....	3
Names of Parts	5
Preparation Before Operation	8

Basic Operation

 AUTO · COOL · DRY · HEAT · FAN ONLY Operation	9
 Adjusting the Airflow Rate.....	11
 Adjusting the Airflow Direction	12

Useful Functions

 COMFORT AIRFLOW Operation.....	13
 INTELLIGENT EYE Operation.....	14
 POWERFUL Operation.....	16
 ECONO Operation	17
 OUTDOOR UNIT QUIET Operation	18
 MOLD PROOF Operation	19

TIMER Operation

 ON/OFF TIMER Operation	20
--	----

Care

Care and Cleaning.....	22
------------------------	----

When the Need Arises

FAQ.....	26
Troubleshooting	27



MOLD PROOF

The MOLD PROOF function dries the interior of the indoor unit and provides an ideal environment to suppress the generation of mold for the indoor unit.

▶Page 19

Safety Precautions



Read the precautions in this manual carefully before operating the unit.



This appliance is filled with R32.

- Keep this manual where the user can easily find it.
- The precautions described herein are classified as WARNING and CAUTION. They both contain important information regarding safety. Be sure to observe all precautions without fail.

WARNING	Failure to follow these instructions properly may result in personal injury or loss of life.
CAUTION	Failure to observe these instructions properly may result in property damage or personal injury, which may be serious depending on the circumstances.

Never attempt.	Be sure to follow the instructions.	Be sure to establish an earth connection.
----------------	-------------------------------------	---

- After reading, keep this manual in a convenient place so that you can refer to it whenever necessary. If the equipment is transferred to a new user, be sure also to hand over the manual.

WARNING

- Do not use means to accelerate the defrosting process or to clean, other than those recommended by the manufacturer.
 - The appliance must be stored in a room without continuously operating ignition sources (for example: open flames, an operating gas appliance or an operating electric heater).
 - Do not pierce or burn.
 - Be aware that refrigerants may not contain an odour.
 - The appliance must be installed, operated and stored in a room with floor area larger than $-^*m^2$.
* Since the maximum refrigerant charge of the models is below 1.22kg, it does not have any limitation for the minimum floor area. Maintain an installation height of 1.8m or more from the floor surface to the bottom of the appliance. If the size of the room where the appliance is to be installed has less than the indicated minimum floor area, install it in a well ventilated room.
 - To avoid fire, explosion or injury, do not operate the unit when harmful gases (e.g. flammable or corrosive) are detected near the unit.
 - Be aware that prolonged, direct exposure to cool or warm air from the air conditioner, or to air that is too cool or too warm, can be harmful to your physical condition and health.
 - Do not place objects, including rods, your fingers, etc., in the air inlet or outlet. Product damage or personal injury may result due to contact with the air conditioner's high-speed fan blades.
 - Do not attempt to repair, dismantle, reinstall or modify the air conditioner yourself as this may result in water leakage, electric shock or fire hazards.
 - Do not use flammable spray near the air conditioner, or otherwise fire may result.
 - Do not use a refrigerant other than the one indicated on the outdoor unit (R32) when installing, moving or repairing. Using other refrigerants may cause trouble or damage to the unit, and personal injury.
 - To avoid electric shock, do not operate with wet hands.
-
- Beware of fire in case of refrigerant leakage. If the air conditioner is not operating correctly, i.e. not generating cool air, refrigerant leakage could be the cause. Consult your dealer for assistance. The refrigerant within the air conditioner is safe and normally does not leak.
However, in the event of a leakage, contact with a naked burner, heater or cooker may result in generation of noxious gas. Do not use the air conditioner until a qualified service person confirms that the leakage has been repaired.
 - Do not attempt to install or repair the air conditioner yourself. Improper workmanship may result in water leakage, electric shock or fire hazards. Please contact your local dealer or qualified personnel for installation and maintenance work.
 - If the air conditioner is malfunctioning (giving off a burning odour, etc.), turn off power to the unit and contact your local dealer. Continued operation under such circumstances may result in a failure, electric shock or fire hazards.
 - Be sure to install an earth leakage circuit breaker. Failure to install an earth leakage circuit breaker may result in electric shock or fire.
-
- Be sure to earth the unit. Do not earth the unit to a utility pipe, lightning conductor or telephone earth lead. Imperfect earthing may result in electric shock.

CAUTION

- Do not use the air conditioner for purposes other than those for which it is intended. Do not use the air conditioner for cooling precision instruments, food, plants, animals or works of art as this may adversely affect the performance, quality and/or longevity of the object concerned.
- Do not expose plants or animals directly to the airflow from the unit as this may cause adverse effects.
- Do not place appliances that produce naked flames in places exposed to the airflow from the unit as this may impair combustion of the burner.
- Do not block the air inlets nor outlets. Impaired airflow may result in insufficient performance or trouble.

- Do not sit on the outdoor unit, put things on the unit, or pull the unit. Doing so may cause accidents, such as falling or toppling down, thus resulting in injury, product malfunctioning, or product damage.
- Do not place objects that are susceptible to moisture directly beneath the indoor or outdoor units. Under certain conditions, condensation on the main unit or refrigerant pipes, air filter dirt or drain blockage may cause dripping, resulting in fouling or failure of the object concerned.
- After prolonged use, check the unit stand and its mounts for damage. If they are left in a damaged condition, the unit may fall and cause injury.
- To avoid injury, do not touch the air inlet or aluminium fins of the indoor or outdoor units.
- The appliance is not intended for use by unattended young children or infirm persons. Impairment of bodily functions and harm to health may result.
- Children should be supervised to ensure that they do not play with the unit or its remote controller. Accidental operation by a child may result in impairment of bodily functions and harm health.
- Avoid impacts to the indoor and outdoor units, or otherwise product damage may result.
- Do not place flammable items, such as spray cans, within 1m of the air outlet.
- The spray cans may explode as a result of hot air from the indoor or outdoor units.
- Be careful not to let pets urinate on the air conditioner. Urination on the air conditioner may result in electric shock or fire.
- Do not wash the air conditioner with water, as this may result in electric shock or fire.
- Do not place water containers (vases, etc.) above the unit, as this may result in electric shock or fire hazards if they should topple over.
- Do not insert the batteries in the wrong polarity (+/-) orientation as this may result in short circuiting, fire, or battery leakage.
- Do not sit or hang on the panel. The panel may fall, and injury or product malfunctioning may result.
- Do not sway the panel. The panel may hit people or objects, and injury or property damage may result.
- Do not let children play around the panel. Injury or property damage may result.
- Do not pull the wires. The wires may be broken and the panel may fall, and injury or property damage may result.
- Do not locate obstacles in the route. The panel may fall, and injury or property damage may result.
- Do not bend or damage the wires. The wires may be broken and the panel may fall, and injury or property damage may result.
- Do not put objects on the panel, or otherwise production malfunctioning may result.
- Do not use an unstable stand at the time of operating or maintaining the air conditioner, or otherwise you may topple over or injury yourself.
- Locate the remote controller in places out of reach of children. The wrong operation of the remote controller may result in injury.

- To avoid oxygen depletion, ensure that the room is adequately ventilated if equipment such as a burner is used together with the air conditioner.
- Before cleaning, be sure to stop unit operation and turn off the circuit breaker. Otherwise, an electric shock and injury may result.
- Only connect the air conditioner to the specified power supply circuit. Power supplies other than the one specified may result in electric shock, overheating and fires.
- Arrange the drain hose to ensure smooth drainage. Imperfect drainage may cause wetting of the building, furniture, etc.
- Do not place objects in direct proximity of the outdoor unit and do not let leaves and other debris accumulate around the unit. Leaves are a hotbed for small animals which can enter the unit. Once inside the unit, such animals can cause malfunctions, smoke or fire if they come into contact with electrical parts.
- Do not place objects around the indoor unit.
Doing so may have an adverse influence on the performance, product quality, and life of the air conditioner.
- This appliance is not intended to be used by persons with reduced physical, sensory or mental capabilities, or with lack of operation knowledge, unless they have been given supervision or instruction concerning the appliance use by person responsible for their safety. Keep out of children's reach to ensure that they do not play with the appliance.

Precautions relating to area surrounding the indoor and outdoor units

- Be sure to follow the instructions below.
 - The indoor unit is at least 1m away from any television or radio set (unit may cause interference with the picture or sound).
 - Refrain from using the units in areas prone to high levels of oily smoke, such as a kitchen. Water leakage may result.

Names of Parts

Indoor Unit

■ FTXV22/28/36

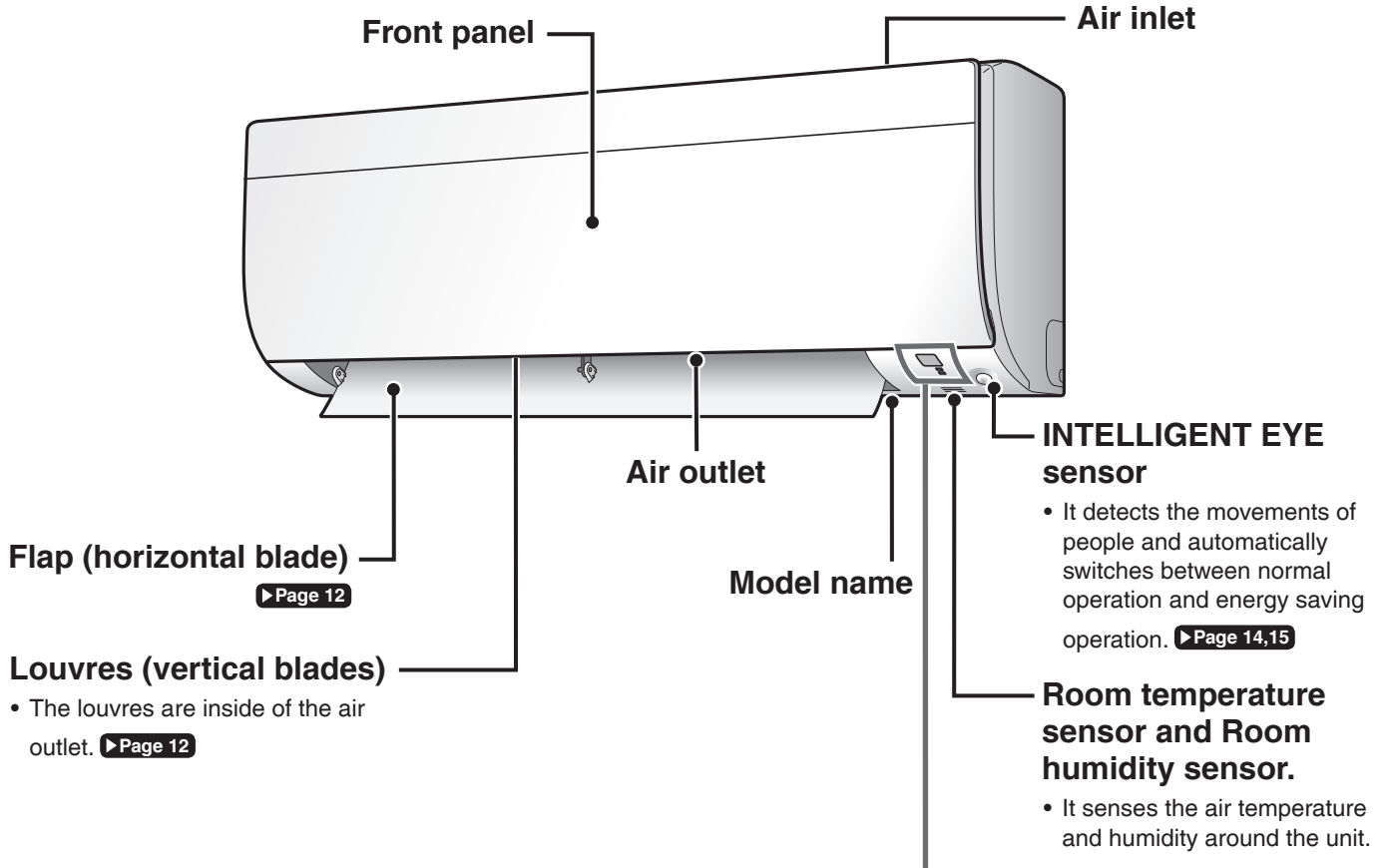

Display

Signal receiver

- Receives signals from the remote controller.
- When the unit receives a signal, you will hear a beep sound.

Case	Sound type
Operation start	beep-beep
Setting changed	beep
Operation stop	long beep

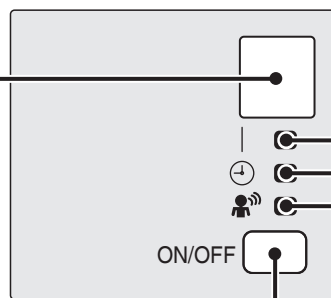

OPERATION lamp (green)

TIMER lamp (orange)

▶Page 20,21

INTELLIGENT EYE lamp (green) : ▶Page 14

Indoor unit ON/OFF switch

- Press this switch once to start operation. Press once again to stop it.
- For the operation mode setting, refer to the following table.

Mode	Temperature setting	Airflow rate
AUTO	25°C	AUTO

- This switch can be used when the remote controller is missing or out of batteries.

■ Open the front panel

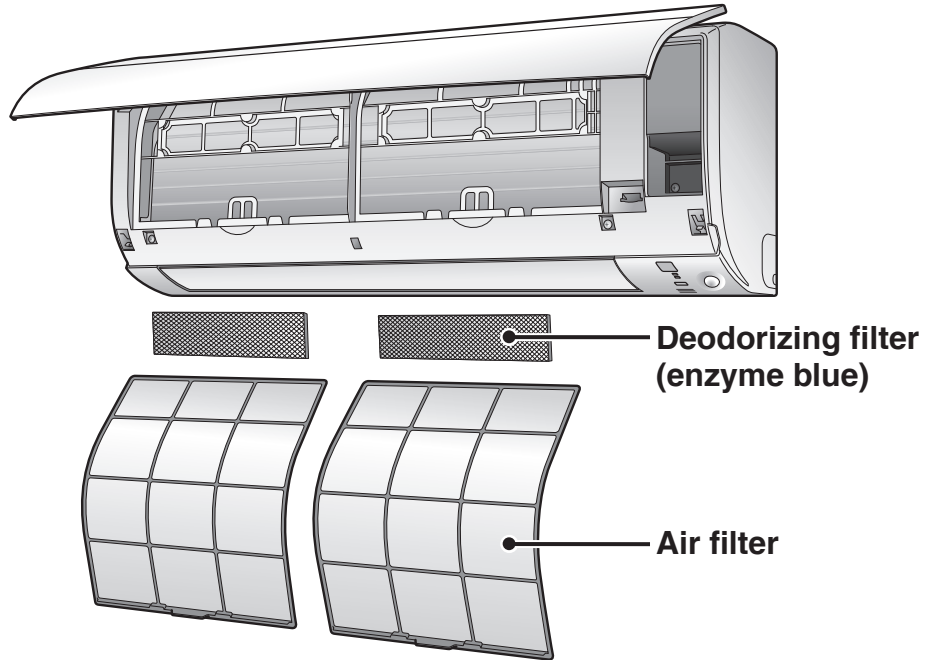

Outdoor Unit

■ RXV22/28

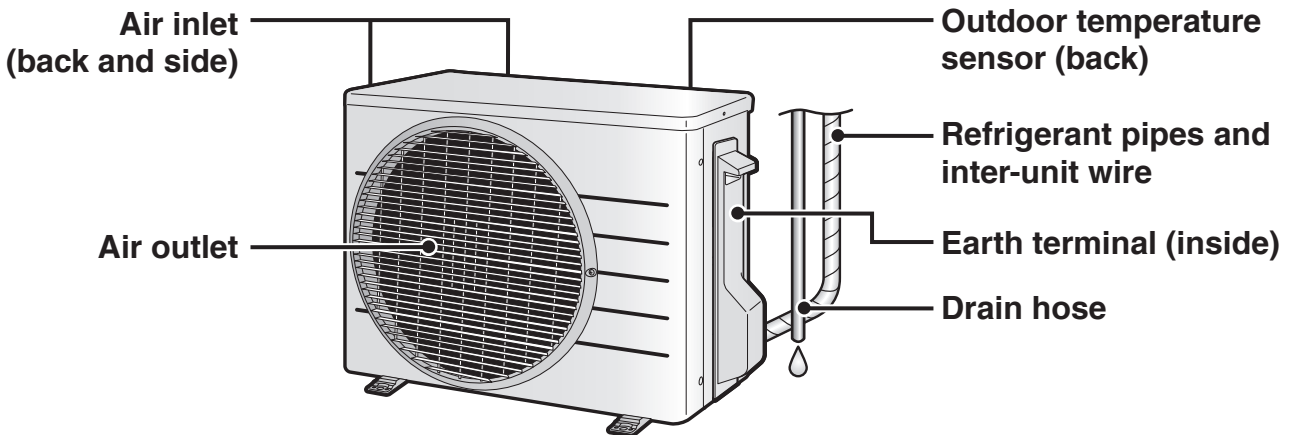

■ RXV36

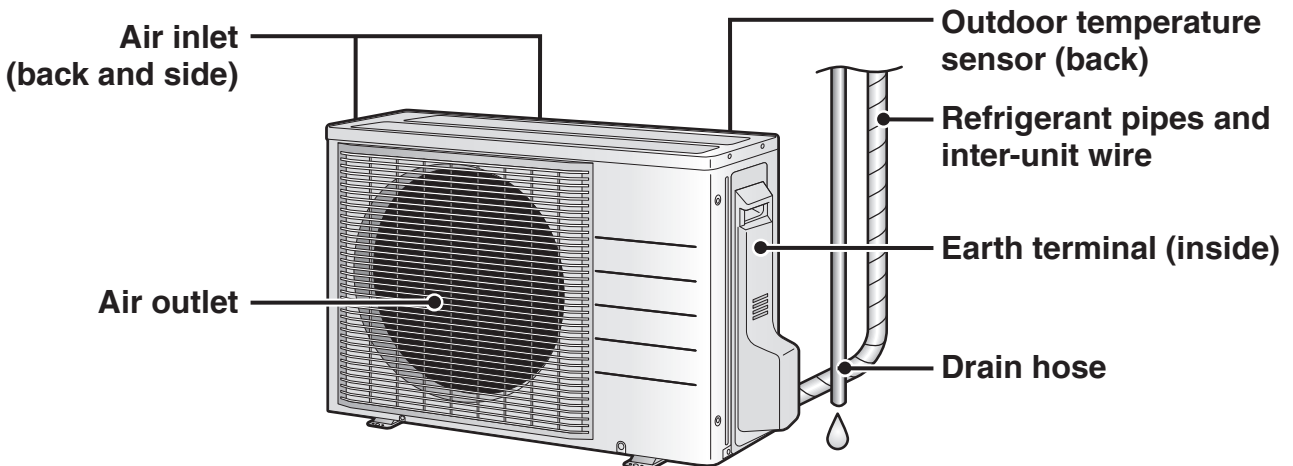

Names of Parts

Remote Controller

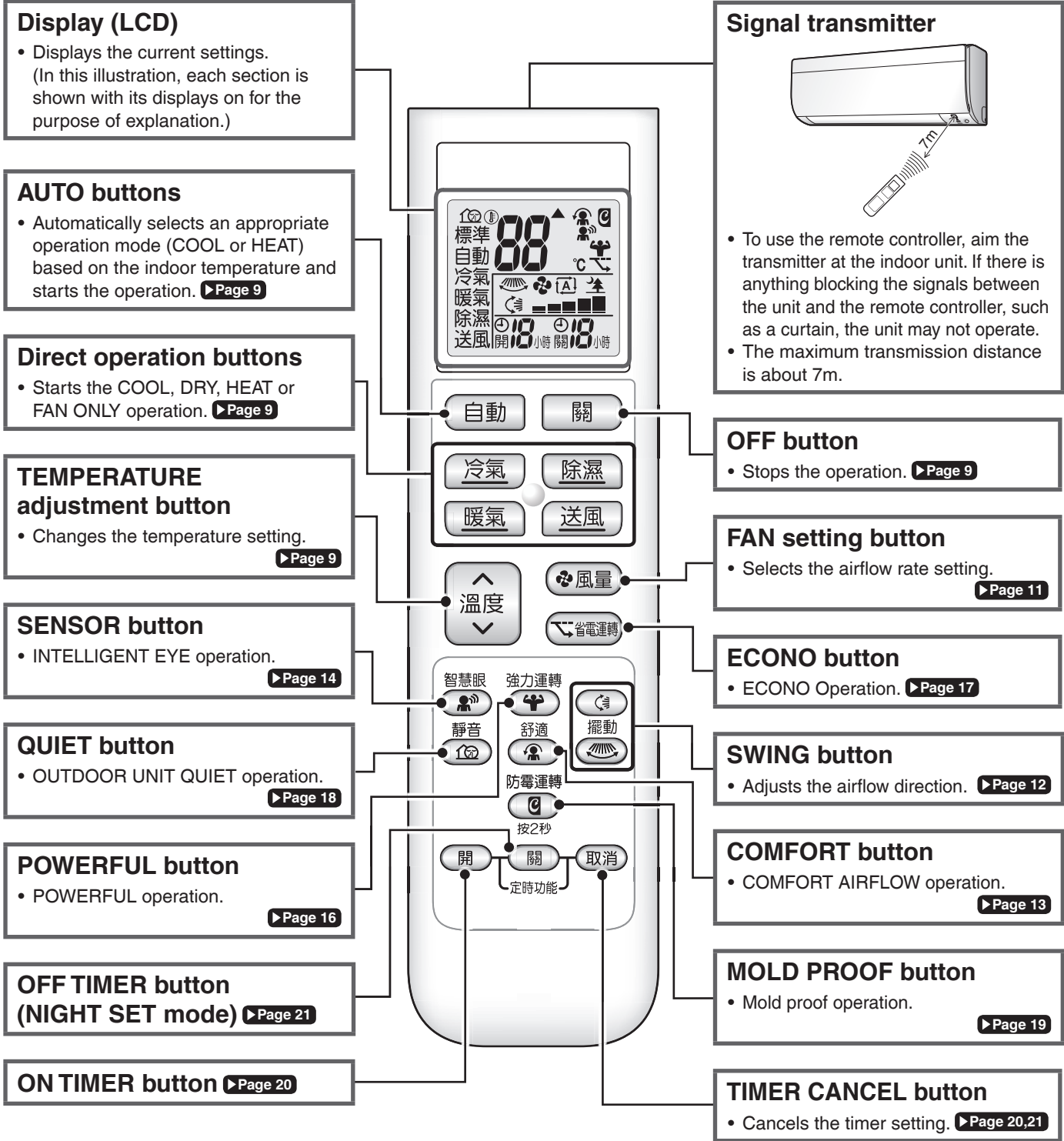

Model name ARC480A65

Preparation Before Operation

CAUTION

Incorrect handling of batteries can result in injury from battery leakage, rupturing or heating, or lead to equipment failure. Please observe the following precautions and use safely.

- If the alkaline solution from the batteries should get in the eyes, do not rub the eyes. Instead, immediately flush the eyes with tap water and seek the attention of a medical professional.
- Keep batteries out of reach of children. In the event that batteries are swallowed, seek the immediate attention of a medical professional.
- Do not expose batteries to heat or fire. Do not disassemble or modify batteries. The insulation or gas release vent inside the battery may be damaged, resulting in battery leakage, rupturing, or heating.
- Do not damage or peel off labels on the batteries.

■ To insert the batteries

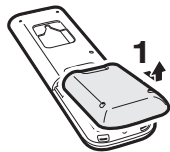

Slide the back cover to take it off.

Position \oplus
and \ominus
correctly!

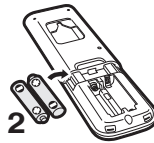

Set two dry batteries AAA.LR03 (alkaline).

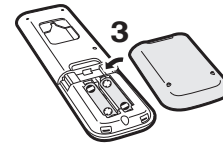

Set the back cover as before.

■ To fix the remote controller holder to a wall

1. Choose a place from where the signals reach the unit.
2. Fix the holder to a wall, a pillar, or similar location with the screws supplied with the holder.
3. Hang the remote controller on the remote controller holder.

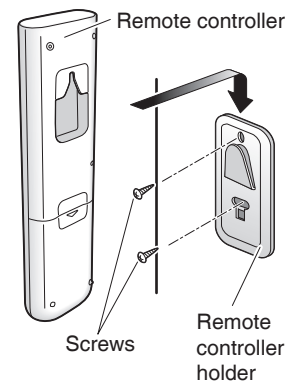

■ To attach the deodorizing filter (enzyme blue)

- If attaching the separately sold filters, attach them before turning the power on. [▶ Page 24](#)

■ Turn on the circuit breaker

- After the power is turned on, the flap of the indoor unit opens and closes once to set the reference position.

NOTE

Notes on batteries

- To avoid possible injury or damage from battery leakage or rupturing, remove the batteries when not using the product for long periods of time.
- The standard replacement time is 1 year. Both batteries should be replaced at the same time. Be sure to replace them with new size AAA.LR03 (alkaline) batteries.
- When battery power has run out, the LCD will begin blinking as an alert that the batteries need replacing. In some cases, when battery consumption is accelerated owing usage conditions, signal reception may decline before the LCD begins blinking.
- The batteries supplied with the remote controller are for initial operation. The batteries may run out in less than 1 year.

Notes on remote controller

- Do not drop the remote controller. Do not get it wet.
- Dust on the signal transmitter or receiver will reduce the sensitivity. Wipe off dust with soft cloth.
- Signal communication may be disabled if an electronic-starter-type fluorescent lamp (such as inverter-type lamps) is in the room. Consult the shop if that is the case.
- If the remote controller signals happen to operate another appliance, move that appliance to somewhere else, or consult the service shop.



AUTO · COOL · DRY · HEAT · FAN ONLY Operation

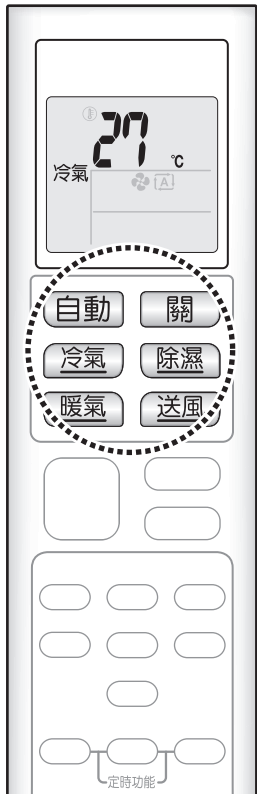

The air conditioner operates with the operation mode of your choice.

■ To start operation

▶ Press the button of your desired operation mode.

AUTO operation

Press . “自動” appears on the LCD.

COOL operation

Press . “冷氣” appears on the LCD.

DRY operation

Press . “除濕” appears on the LCD.

HEAT operation

Press . “暖氣” appears on the LCD.

FAN ONLY operation

Press . “送風” appears on the LCD.

- The OPERATION lamp lights green.

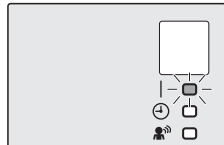

Display

- The operation mode can be changed while the air conditioner is operating by pressing the button of your desired operation mode.

■ To stop operation

▶ Press .

- The OPERATION lamp goes off.

NOTE

Notes on AUTO operation

- In AUTO operation, the system selects an appropriate operation mode (COOL or HEAT) based on the indoor temperature, then starts the operation.
- The system automatically reselects setting at a regular interval to bring the indoor temperature to user-setting level.

Note on COOL operation

- This air conditioner cools the room by releasing the heat in the room outside.
Therefore, the cooling performance of the air conditioner may be degraded if the outdoor temperature is high.

Note on DRY operation

- Eliminates humidity while maintaining the indoor temperature as much as possible. It automatically controls temperature and airflow rate, so manual adjustment of these functions is unavailable.

Notes on HEAT operation

- Since this air conditioner heats the room by taking heat from outdoor air to indoors, the heating capacity becomes smaller in lower outdoor temperatures. If the heating effect is insufficient, it is recommended to use another heating appliance in combination with the air conditioner.
- The heat pump system heats the room by circulating hot air around all parts of the room. After the start of HEAT operation, it takes some time before the room gets warmer.
- In HEAT operation, frost may occur on the outdoor unit and lower the heating capacity. In that case, the system switches into defrosting operation to take away the frost.



Note on FAN ONLY operation

- This mode is valid for fan only.



■ To change the temperature setting

▶ Press  .

- Press  to raise the temperature and press  to lower the temperature. Each pressing of the button changes the temperature by 1°C.

COOL operation	HEAT operation	AUTO operation	DRY operation	FAN ONLY operation
18~32°C	10~30°C	18~30°C	"STD-(STD - 3°C)" *1, *2	The temperature setting cannot be changed.

*1 STD (Standard)...Indoor temperature at the time when the DRY operation is started.

*2 STD (Standard)... "除濕" and "標準" appear on the LCD.

[Dry (Dehumidifying)]

■ To use Dry (Dehumidifying) mode

▶ Press  .

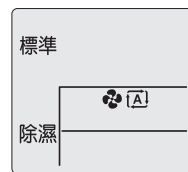

- "除濕" and "標準" appear on the LCD.
- The DRY operation start.

- Press  to raise the temperature and press  to lower the temperature 1°C each press.

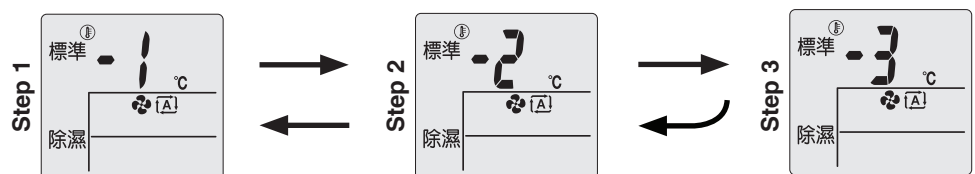

- This mode mixes dehumidified cool air with room air to adjust the air outlet temperature and remove moisture.
- When the indoor temperature rises, the COOLING operation automatically starts.
- When the outdoor temperature is lower than the indoor temperature, dehumidifying is less effective.
- In order to lower the humidity, the airflow rate during the DRY operation is automatically controlled.



Adjusting the Airflow Rate

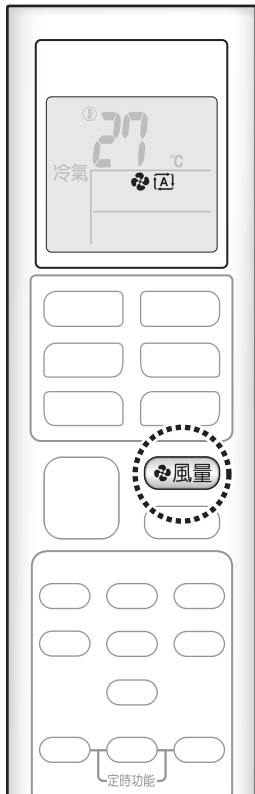

You can adjust the airflow rate to increase your comfort.

■ To adjust the airflow rate setting

▶ Press  .

- Each pressing of  changes the airflow rate setting in sequence.



- When the airflow is set to “”, quiet operation starts and noise from the indoor unit will become quieter.
- In the quiet operation mode, the airflow rate is set to a weak level.
- If COOL/DRY operation is started with airflow settings on “AUTO”, the indoor unit will initially deodorise, which functions to suppress any internal odours. As a result, the indoor unit will not emit air immediately. (Wait for about 1 minute.)
- At smaller airflow rates, the cooling (heating) effect is also smaller.

Tips for saving energy

Keeping the temperature setting at a moderate level helps save energy.

- Recommended temperature setting
 - For cooling: 26-28°C
 - For heating: 20-24°C

Cover windows with a blind or a curtain.

- Blocking sunlight and air from outdoors increases the cooling (heating) effect.

Keep the air filters clean.

- Clogged air filters cause inefficient operation and waste energy. Clean them once in about every 2 weeks. ▶ [Page 23](#)

If you are not going to use the air conditioner for a long period, for example in spring or autumn, turn off the circuit breaker.

- The air conditioner always consumes a small amount of electricity even while it is not operating.



Adjusting the Airflow Direction

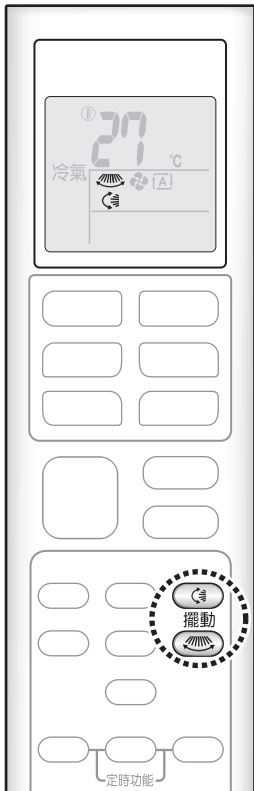

You can adjust the airflow direction to increase your comfort.

⚠ CAUTION

- Always use a remote controller to adjust the angles of the flap and louvres.
 - If you attempt to move the flap and louvres forcibly by hand when they are swinging, the mechanism may be damaged.
 - Inside the air outlet, a fan is rotating at a high speed.

■ To start auto swing

Up and down airflow direction

▶ Press .

- “” appears on the LCD.
- The flap (horizontal blade) will begin to swing.

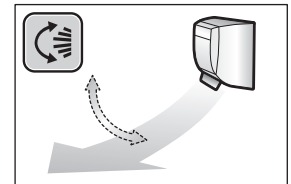

Right and left airflow direction



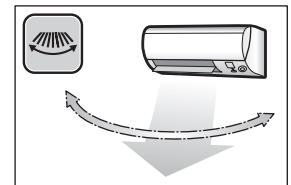

▶ Press .

- “” appears on the LCD.
- The louvres (vertical blades) will begin to swing.



The 3-D airflow direction

▶ Press  and .

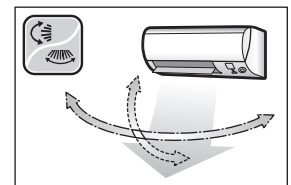

- “” and “” appear on the LCD.
- The flap and louvres move in turn.
- To cancel 3-D airflow, press either  or  again. The flap or louvres will stop moving.



■ To set the flap or louvres at the desired position

- This function is effective while the flap or louvres are in auto swing mode.

▶ Press  and  when the flap or louvres reach the desired position.

- In the 3-D airflow, the flap and louvres move in turn.
- “” or “” disappears from the LCD.

NOTE

Notes on airflow direction setting

- The movable range of the flap varies according to the operation mode.

Note on 3-D airflow

- Using 3-D airflow circulates cold air, which tends to collect at the bottom of the room, and hot air, which tends to collect near the ceiling, throughout the room, preventing areas of cold and hot developing.

Movable range of the flap

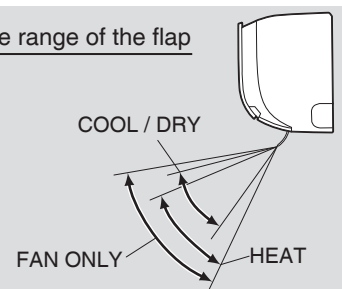



COMFORT AIRFLOW Operation

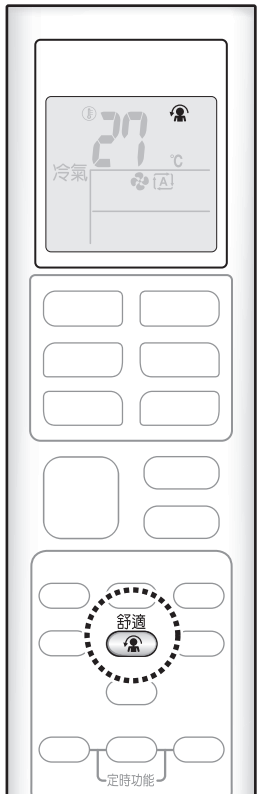

The flow of air will be in the upward direction while in COOL operation and in the downward direction while in HEAT operation, which will provide a comfortable wind that will not come in direct contact with people.

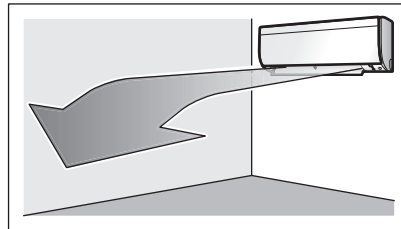

COOL operation

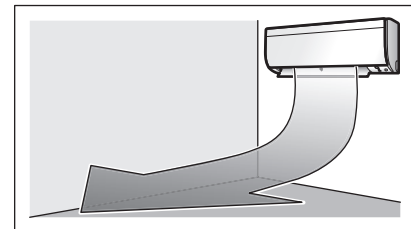

HEAT operation

■ To start

▶ Press  .

- “” appears on the LCD.

	COOL and DRY operation	HEAT operation	FAN ONLY operation
Flap direction	Goes up	Goes down	Not available
Airflow rate	AUTO		

■ To cancel

▶ Press  again.

- “” disappears from the LCD.
- The flap will return to the memory position from before COMFORT AIRFLOW operation.

NOTE

Notes on COMFORT AIRFLOW Operation

- The flap position will change, preventing air from blowing directly on the occupants of the room.
- POWERFUL operation and COMFORT AIRFLOW operation cannot be used at the same time.
- The airflow rate will be set to AUTO. If the upper and lower airflow direction is selected, the COMFORT AIRFLOW operation will be canceled. Priority is given to the function of whichever button is pressed last.



INTELLIGENT EYE Operation

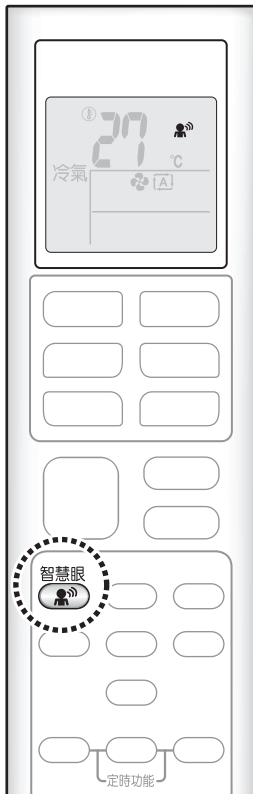

“INTELLIGENT EYE” is the infrared sensor which detects the human movement. If no one is in the room for more than 20 minutes, the operation automatically changes to energy saving operation.

⚠ CAUTION

- Do not place large objects near the INTELLIGENT EYE sensor. Also keep heating units and humidifiers outside the sensor's detection area. This sensor can detect undesirable objects.
- Do not hit or violently push the INTELLIGENT EYE sensor. This can lead to damage and malfunction.

■ To start

▶ Press  .

- “” appears on the LCD.
- The INTELLIGENT EYE lamp lights green.
- The lamp will be lit while human movements are detected.

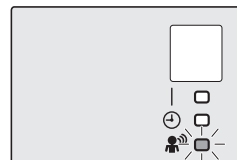

Display

■ To cancel

▶ Press  until no icon is displayed.

- The INTELLIGENT EYE lamp goes off.



INTELLIGENT EYE Operation

NOTE

Energy saving operation

- If no presence detected in the room for 20 minutes, the energy saving operation will start, and the INTELLIGENT EYE lamp goes off. If human movement is detected again, the INTELLIGENT EYE lamp lights up and energy saving operation terminates.
- This operation changes the temperature by -2°C in HEAT / $+2^{\circ}\text{C}$ in COOL / $+2^{\circ}\text{C}$ in DRY operation from the set temperature. When the room temperature exceeds 30°C , the operation changes the temperature by $+1^{\circ}\text{C}$ in COOL / $+1^{\circ}\text{C}$ in DRY operation from the set temperature.
- This operation decreases the airflow rate slightly in FAN operation only.

Notes on INTELLIGENT EYE operation

- Application range is as follows.

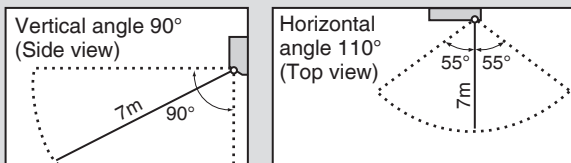

- The air conditioner may switch to the energy-saving operation even if there are people in the areas. This may occur depending on the clothes the people are wearing, if there is no movement of the people in the areas.
- Due to the position of the sensor, people might be exposed to the airflow of the indoor unit if they are close to the front side of the indoor unit.
- The sensor could also mistakenly detect pets, sunlight, fluttering curtains and light reflected off of mirrors as passers-by.
- The sensor may not detect moving objects further than 7m away. (Please see the application range)
- Sensor detection sensitivity changes according to the indoor unit location, the speed of passers-by, temperature range, etc.
- NIGHT SET mode [▶Page 21](#) will not switch on during use of INTELLIGENT EYE operation.



POWERFUL Operation

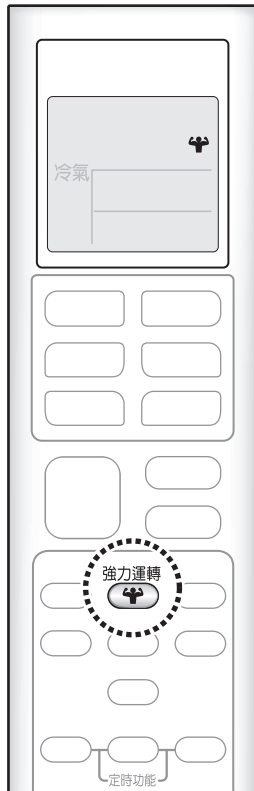

POWERFUL operation quickly maximises the cooling (heating) effect in any operation mode. In this mode, the air conditioner operates at maximum capacity.

■ To start

▶ Press ^{強力運轉}  during operation.

- “” appears on the LCD.
- POWERFUL operation ends in 20 minutes. Then the system automatically operates again with the previous settings which were used before POWERFUL operation.



■ To cancel

▶ Press ^{強力運轉}  again.

- “” disappears from the LCD.

NOTE

Notes on POWERFUL operation

- Pressing  causes the settings to be cancelled, and “” disappears from the LCD.
- POWERFUL operation will not increase the capacity of the air conditioner if the air conditioner is already in operation with its maximum capacity demonstrated.
 - In COOL, HEAT and AUTO operation
To maximise the cooling (heating) effect, the capacity of outdoor unit increases and the airflow rate becomes fixed at the maximum setting. The temperature and airflow settings cannot be changed.
 - In DRY operation
The temperature setting is lowered by 2.5°C and the airflow rate is slightly increased.
 - In FAN ONLY operation
The airflow rate is fixed at the maximum setting.

Regarding the combination of POWERFUL and other operations

POWERFUL + COMFORT AIRFLOW	Not available*
POWERFUL + ECONO	
POWERFUL + OUTDOOR UNIT QUIET	

*Priority is given to the function of whichever button is pressed last.



ECONO Operation



ECONO operation enables efficient operation by limiting the maximum power consumption.

This function is useful to prevent the circuit breaker from tripping when the unit operates alongside other appliances on the same circuit.

■ To start

▶ Press  .

- “” appears on the LCD.
- Not available in FAN ONLY mode.



■ To cancel

▶ Press  again.

- “” disappears from the LCD.

NOTE

Notes on ECONO operation

- This operation is performed with lower power and therefore may not provide a sufficient cooling (heating) effect.
- Pressing  causes the settings to be cancelled, and “” disappears from the LCD.
- If the power consumption level is already low, switching to ECONO operation will not reduce the power consumption.

Possible combinations of ECONO operation and basic operations

ECONO	Operation mode				
	AUTO	DRY	COOL	HEAT	FAN ONLY
	√	√	√	√	—

Some useful functions can be used together.

COMFORT AIRFLOW + ECONO	Available
OUTDOOR UNIT QUIET + ECONO	



OUTDOOR UNIT QUIET Operation

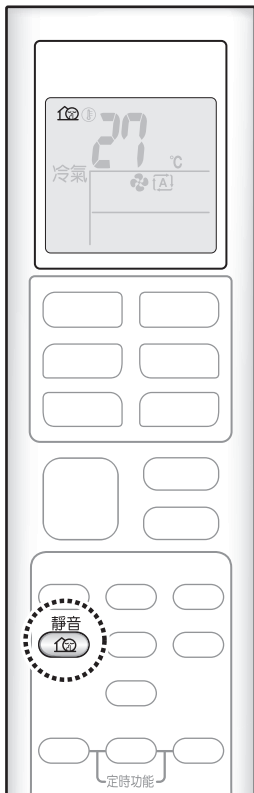

OUTDOOR UNIT QUIET operation lowers the noise level of the outdoor unit by changing the frequency and fan speed on the outdoor unit. This function is convenient during night.

■ To start

▶ Press  .

- “” appears on the LCD.

■ To cancel

▶ Press  again.

- “” disappears from the LCD.

NOTE

Notes on OUTDOOR UNIT QUIET operation

- POWERFUL operation and OUTDOOR UNIT QUIET operation cannot be used at the same time. Priority is given to the function of whichever button is pressed last.
- Even the operation is stopped by using the remote controller or the indoor unit ON/OFF switch when using OUTDOOR UNIT QUIET operation, “” will remain on the remote controller display.
- OUTDOOR UNIT QUIET operation will drop neither the frequency nor fan speed if they have been already dropped low enough.

Possible combinations of OUTDOOR UNIT QUIET operation and basic operations

OUTDOOR UNIT QUIET	Operation mode				
	AUTO	DRY	COOL	HEAT	FAN ONLY
	√	–	√	√	–



MOLD PROOF Operation

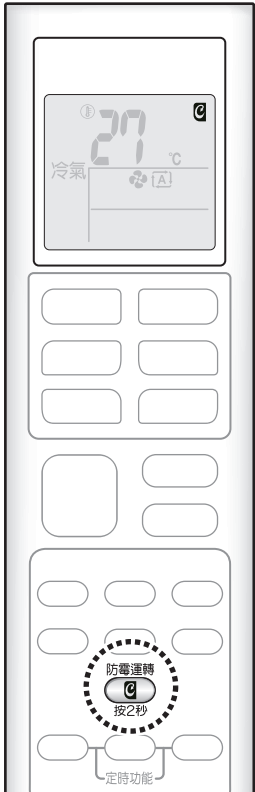

MOLD PROOF operation is a function which reduces the spread of mold by using FAN operation to lower the humidity inside the indoor unit.

[To automatically operation]

■ To start

- ▶ Press  and hold the button for two seconds.

- “” appears on the LCD.

■ To cancel

- ▶ Press  and hold the button for two seconds one more time.

- “” disappears from the LCD.

[To manually operation]

- ▶ Press  for about 2 seconds while the unit is not operation.

- “” blinks on the LCD, and the display returns to normal after a while.

NOTE

Notes on MOLD PROOF operation

- When you want to stop MOLD PROOF operation midway, press .
- After DRY or COOL operation stops, the air conditioner starts MOLD PROOF operation automatically, and then stops automatically 60 minutes later.
- This function is not designed to remove existing dust or mold.
- MOLD PROOF operation is not available when the unit is turned off using the OFF TIMER.



ON/OFF TIMER Operation

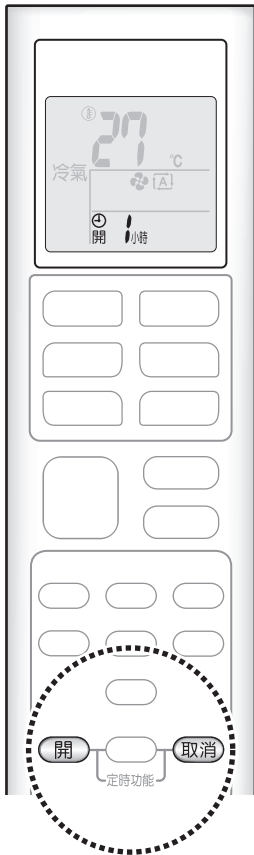

Timer functions are useful for automatically switching the air conditioner on or off in the morning or at night. You can also use the ON TIMER and OFF TIMER together.

[ON TIMER operation]

■ To set

▶ Press **開**.



- Each pressing of **開** changes the time setting by 1 hour. The time can be set between 1 and 12 hours.
- The TIMER lamp lights orange.

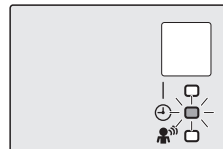

Display

■ To cancel

▶ Press **取消**.

- "開 1小時" disappears from the LCD.
- The TIMER lamp goes off.

NOTE

In the following cases, set the timer again.

- After the circuit breaker has turned off.
- After a power failure.
- After replacing the batteries in the remote controller.



ON/OFF TIMER Operation

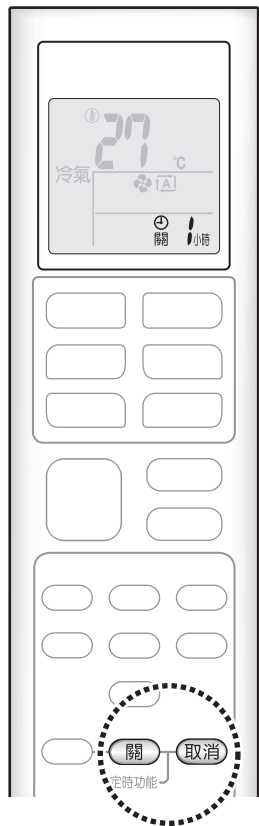

[OFF TIMER operation]

■ To set

▶ Press .



- Each pressing of  changes the time setting by 1 hour. The time can be set between 1 and 12 hours.
- The TIMER lamp lights orange.

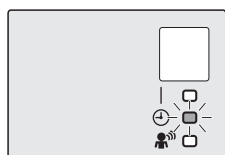

Display

■ To cancel

▶ Press .

- “開 1小時” disappears from the LCD.
- The TIMER lamp goes off.

[ON/OFF TIMER combination]

■ To combine

- A sample setting for combining the 2 timers is shown below.
- “開” and “關” are appears on the LCD.

[Example]



When setting while the unit is operating

- Stops the unit 1 hour later and starts it 7 hours after that.



When setting while the unit is stopped

- Starts the unit 2 hours later and stops it 3 hours after that.

NOTE

NIGHT SET mode

- When the OFF TIMER is set, the air conditioner automatically adjusts the temperature setting (0.5°C up in COOL, 2.0°C down in HEAT) to prevent excessive cooling (heating) during sleeping hours.

Care and Cleaning

⚠ CAUTION

- Before cleaning, be sure to stop the operation and turn off the circuit breaker.
- Do not touch the aluminium fins of the indoor unit. If you touch those parts, this may cause an injury.

■ Quick reference

Cleaning parts

Front panel

- Wipe it with a soft damp cloth.
- Only neutral detergent may be used.

If dirty

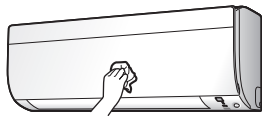

Air filter

- Vacuum dust or wash the filter.

Once every 2 weeks

▶ Page 23

Indoor unit, outdoor unit and remote controller

- Wipe them with a soft cloth.

If dirty

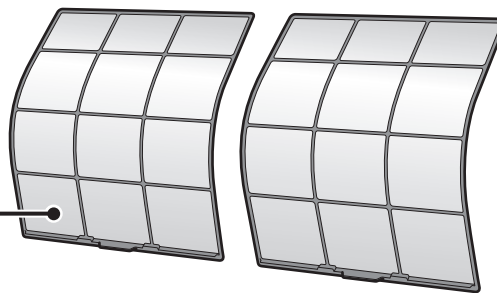
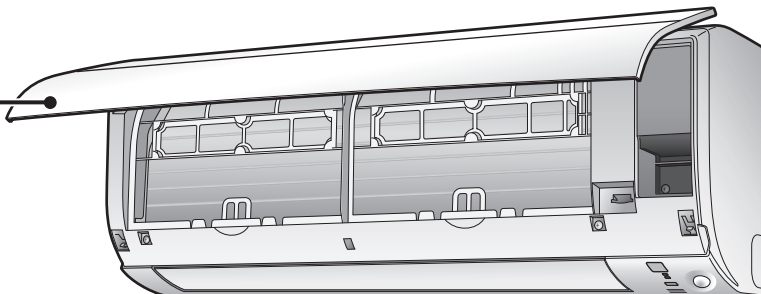

Deodorizing filter (enzyme blue)

To purchase the filters (Table 1) or to purchase the another type, contact the dealer where you bought the air conditioner.

For cleaning and replacement of filter some may differ from some model, refer to label attachments in separately sold part.

Table 1

Item	Part No.
Deodorizing filter (enzyme blue) - without frame (set of 2)	BAFP094A41
Dust collection filter (PM 2.5) - without frame (set of 2)	BAFP046A41
Titanium apatite deodorizing filter - without frame (set of 2)	KAF970A46

Deodorizing filter (enzyme blue), titanium apatite deodorizing filter.

- Vacuum dust or replace the filter.

[Cleaning]

Once every 6 months

▶ Page 24

[Replacement]

Once every 3 years

▶ Page 24

Dust collection filter (PM 2.5)

- No cleaning is required. Please replace the filter every 6 months. ▶ Page 24

NOTE

For cleaning, do not use any of the following:

- Water hotter than 40°C
- Volatile liquid such as benzene, petrol and thinner
- Polishing compounds
- Rough materials such as a scrubbing brush

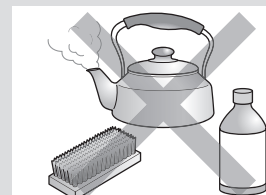

Care and Cleaning

⚠ CAUTION

- Do not touch the aluminium fins by bare hand at the time of dismounting or mounting the filter.

■ Air filter

1. Open the front panel.

- Hold the front panel by the sides and open it.

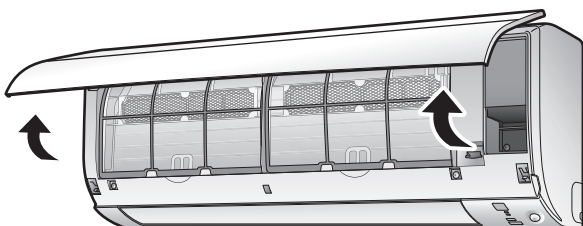

2. Pull out the air filters.

- Push the air filter tab at the centre of each air filter a little upwards, then pull it down.

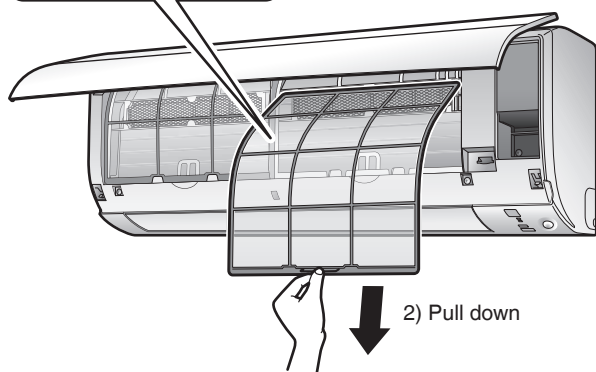
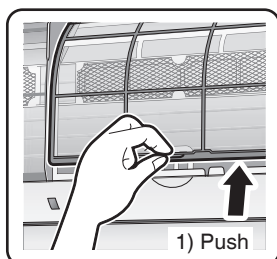

3. Wash the air filters with water or clean them with vacuum cleaner.

- It is recommended to clean the air filters every 2 weeks.

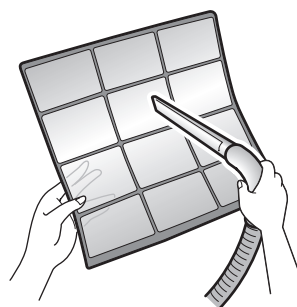

If the dust does not come off easily

- Wash the air filters with neutral detergent thinned with lukewarm water, then dry them up in the shade.



4. Reattach the filters.

5. Close the front panel slowly.

- Press the panel at both sides and the centre.

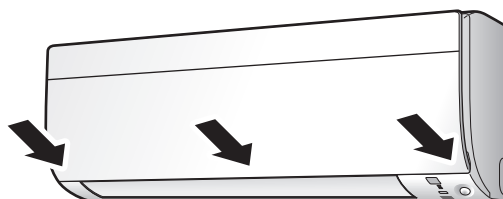

- Make sure that the front panel is securely fixed.

■ Filter (small)

* For the applicable filter type, please refer to ▶Page 22.

Attaching

1. Open the front panel and pull out the air filters. ▶Page 23

2. Insert the filter.

- Check that the filters are inserted securely under the tabs.

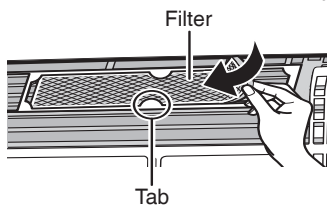

Cleaning and Replacement

1. Open the front panel and pull out the air filters. ▶Page 23

2. Take off the filter.

- Remove the filters from the tabs.

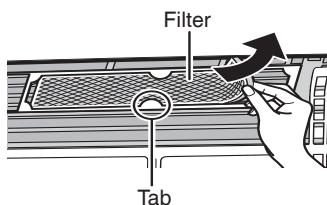

3. Clean or replace.

[Cleaning]

▶ **Deodorizing filter (enzyme blue) :**
Blue-Black / titanium apatite
deodorizing filter : Blue-Black

3-1 Vacuum dust, and soak in lukewarm water or water for about 10 to 15 minutes if very dirty.

3-2 After washing, shake off remaining water and let them dry in the shade.

- This filter can be renewed by washing it with water once **every 6 months** and we recommend replacing it once **every 3 years**.
- Do not wiring out the filter when removing water from it.

▶ **Dust collection filter (PM 2.5) :**
White

- Do not wash the filters as this will reduce their efficiency.
- It is recommended to replace it once **every 6 months**.

[Replacement]

Remove each filter from the front grille by detaching them from the 6 tabs and then install the new filters.

- When attaching the filter, check that the filter is properly set in the tabs.

4. Set the filters as they were and close the front panel.

- Press the front panel at both sides and the center.

NOTE

- Operation with dirty filters:
 - cannot deodorise the air,
 - cannot clean the air,
 - results in poor heating or cooling,
 - may cause odour.
- Dispose of old filters as non-flammable waste.

Care and Cleaning

■ Prior to a long period of non-use

- 1. Operate the MOLD PROOF mode.** ▶Page 19

- 2. After operation stops, turn off the circuit breaker for the room air conditioner.**

- 3. Clean the air filters and reattach them.** ▶Page 23

- 4. To prevent battery leakage, take out the batteries from the remote controller.**

■ We recommend periodical maintenance

- In certain operating conditions, the inside of the air conditioner may get foul after several seasons of use, resulting in poor performance. It is recommended to have periodical maintenance by a specialist in addition to regular cleaning by the user.
- For specialist maintenance, please contact the dealer where you bought the air conditioner.
- The maintenance cost must be borne by the user.

FAQ

Indoor unit

The flap does not start swinging immediately.

- The air conditioner is adjusting the position of the flap. The flap will start moving soon.

The air conditioner stops generating airflow during HEAT operation.

- Once the set temperature is reached, the airflow rate is reduced and operation stopped in order to avoid generating a cool airflow. Operation will resume automatically when the indoor temperature falls.

HEAT operation stops suddenly and a flowing sound is heard.

- The outdoor unit is defrosting. HEAT operation starts after the frost on the outdoor unit has been removed. This can take about 4 to 12 minutes.

Operation does not start soon.

- When **自動** or any direct operation button was pressed soon after operation was stopped.
- When the mode was reselected.
 - This is to protect the air conditioner. You should wait for about 3 minutes.

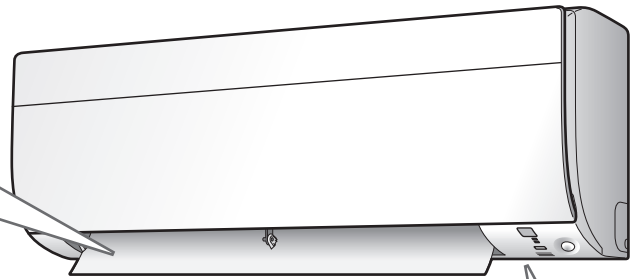

Different sounds are heard.

■ A sound like flowing water

- This sound is generated because the refrigerant in the air conditioner is flowing.
- This is a pumping sound of the water in the air conditioner and can be heard when the water is pumped out from the air conditioner during COOL or DRY operation.

■ Blowing sound

- This sound is generated when the flow of the refrigerant in the air conditioner is switched over.

■ Ticking sound

- This sound is generated when the cabinet and frame of the air conditioner slightly expand or shrink as a result of temperature changes.

■ Whistling sound

- This sound is generated when refrigerant flows during defrosting operation.

■ Clicking sound during operation or idle time

- This sound is generated when the refrigerant control valves or the electrical parts operate.

■ Clapping sound

- This sound is heard from the inside of the air conditioner when the exhaust fan is activated while the room doors are closed. Open the window or turn off the exhaust fan.

Outdoor unit

The outdoor unit emits water or steam.

■ In HEAT operation

- The frost on the outdoor unit melts into water or steam when the air conditioner is in defrosting operation.

■ In COOL or DRY operation

- Moisture in the air condenses into water on the cool surface of the outdoor unit piping and drips.

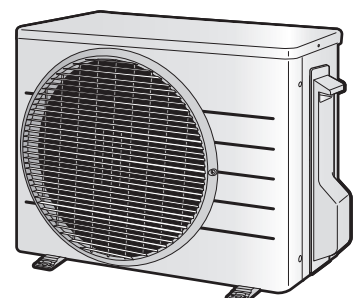

* Appearance of the outdoor unit may differ from some models.

Troubleshooting

Before making an inquiry or a request for repair, please check the following.
If the problem persists, consult your dealer.



Not a problem

This case is not a problem.



Check

Please check again before requesting repairs.

The air conditioner does not operate

Case	Description / what to check
OPERATION lamp is off.	<ul style="list-style-type: none"> • Has the circuit breaker been tripped or the fuse blown? • Is there a power failure? • Are batteries set in the remote controller?
OPERATION lamp is blinking.	<ul style="list-style-type: none"> • Turn off the power with the circuit breaker and restart operation with the remote controller. If the OPERATION lamp is still blinking, check the error code and consult your dealer. ▶Page 30

The air conditioner suddenly stops operating

Case	Description / what to check
OPERATION lamp is on.	<ul style="list-style-type: none"> • To protect the system, the air conditioner may stop operating after sudden large voltage fluctuations. It automatically resumes operation in about 3 minutes.
OPERATION lamp is blinking.	<ul style="list-style-type: none"> • Are the air filters dirty? Clean the air filters. • Is there anything blocking the air inlet or air outlet of the indoor unit or outdoor unit? Stop operation and after turning off the circuit breaker, remove the obstruction. Then restart operation with the remote controller. If the OPERATION lamp is still blinking, check the error code and consult your dealer. ▶Page 30

The air conditioner does not stop operating

Case	Description / what to check
The air conditioner continues operating even after operation is stopped.	<ul style="list-style-type: none"> <ul style="list-style-type: none"> ■ Immediately after the air conditioner is stopped <ul style="list-style-type: none"> • The outdoor unit fan continues rotating for about another 1 minute to protect the system. ■ While the air conditioner is not in operation <ul style="list-style-type: none"> • When the outdoor temperature is high, the outdoor unit fan may start rotating to protect the system.

The room does not cool down / warm up

Case	Description / what to check
Air does not come out	<ul style="list-style-type: none"> <ul style="list-style-type: none"> ■ In HEAT operation <ul style="list-style-type: none"> • The air conditioner is warming up. Wait for about 1 to 4 minutes. • During defrosting operation, hot air does not flow out of the indoor unit. ■ When the air conditioner operates immediately after the circuit breaker is turned on <ul style="list-style-type: none"> • The air conditioner is preparing to operate. Wait for about 3 to 20 minutes.
Air does not come out / Air comes out.	<ul style="list-style-type: none"> <ul style="list-style-type: none"> ■ Is the airflow rate setting appropriate? <ul style="list-style-type: none"> • Is the airflow rate setting low, such as "Indoor unit quiet" or "Airflow rate 1"? Increase the airflow rate setting. ■ Is the set temperature appropriate? ■ Is the adjustment of the airflow direction appropriate?
Air comes out.	<ul style="list-style-type: none"> <ul style="list-style-type: none"> • Is there any furniture directly under or beside the indoor unit? • Is the air conditioner in ECONO operation or OUTDOOR UNIT QUIET operation? ▶Page 17,18 • Are the air filters dirty? • Is there anything blocking the air inlet or air outlet of the indoor unit or outdoor unit? • Is a window or door open? • Is an exhaust fan turning?

Mist comes out

Case	Description / what to check
Mist comes out of the indoor unit.	<input checked="" type="checkbox"/> <ul style="list-style-type: none"> This happens when the air in the room is cooled into mist by the cold airflow during COOL or other operation.

Remote controller

Case	Description / what to check
The unit does not receive signals from the remote controller or has a limited operating range.	<input checked="" type="checkbox"/> <ul style="list-style-type: none"> The batteries may be exhausted. Replace both batteries with new dry batteries AAA.LR03 (alkaline). For details, refer to "Preparation Before Operation". ▶Page 8 Signal communication may be disabled if an electronic-starter-type fluorescent lamp (such as inverter-type lamps) is in the room. Consult your dealer if that is the case. The remote controller may not function correctly if the transmitter is exposed to direct sunlight.
LCD is faint, is not working, or the display is erratic.	<input checked="" type="checkbox"/> <ul style="list-style-type: none"> The batteries may be exhausted. Replace both batteries with new dry batteries AAA.LR03 (alkaline). For details, refer to "Preparation Before Operation". ▶Page 8
The LCD is blinking and the remote controller cannot be operated.	<input checked="" type="checkbox"/> <ul style="list-style-type: none"> Battery power has run out. Replace both batteries at the same time with new size AAA.LR03 (alkaline) batteries. Leaving exhausted batteries in the remote controller can result in injury due to battery leakage, rupturing or heating, or lead to equipment failure. (Even when the LCD is blinking, the OFF button remains functional.)
Other electric devices start operating.	<input checked="" type="checkbox"/> <ul style="list-style-type: none"> If the remote controller activates other electric devices, move them away or consult your dealer.

Air has an odour

Case	Description / what to check
The air conditioner gives off an odour.	<input checked="" type="checkbox"/> <ul style="list-style-type: none"> The room odour absorbed in the unit is discharged with the airflow. We recommend you to have the indoor unit cleaned. Please consult your dealer.

Others

Case	Description / what to check
The air conditioner suddenly starts behaving strangely during operation.	<input type="checkbox"/> <ul style="list-style-type: none"> The air conditioner may malfunction due to lightning or radio. If the air conditioner malfunctions, turn off the power with the circuit breaker and restart the operation with the remote controller.

NOTE

Notes on the operating conditions

- If operation continues under any conditions other than those listed in the table,
 - A safety device may activate to stop the operation.
 - Dew may form on the indoor unit and drip from it when COOL or DRY operation is selected.

Mode	Operating conditions
COOL / DRY	Outdoor temperature: 10~46°C Indoor temperature: 18~32°C Indoor humidity: 80% max.
HEAT	Outdoor temperature: -15~24°C Indoor temperature: 10~30°C

Troubleshooting

■ Call your dealer immediately

WARNING

When an abnormality (such as a burning smell) occurs, stop operation and turn off the circuit breaker.

- Continued operation in an abnormal condition may result in problems, electric shock or fire.
- Consult the dealer where you bought the air conditioner.

Do not attempt to repair or modify the air conditioner by yourself.

- Incorrect work may result in electric shock or fire.
- Consult the dealer where you bought the air conditioner.

If one of the following symptoms takes place, call your dealer immediately.

- The power cord is abnormally hot or damaged.
- An abnormal sound is heard during operation.
- The circuit breaker, a fuse, or the earth leakage circuit breaker cuts off the operation frequently.
- A switch or a button often fails to work properly.
- There is a burning smell.
- Water leaks from the indoor unit.

Turn off the circuit breaker and call your dealer.



■ After a power failure

- The air conditioner automatically resumes operation in about 3 minutes. You should just wait for a while.

■ Lightning

- If there is a risk lightning could strike in the neighbourhood, stop operation and turn off the circuit breaker to protect the system.

■ Disposal requirements

- Dismantling of the unit, handling of the refrigerant, oil and other parts, should be done in accordance with the relevant local and national regulations.

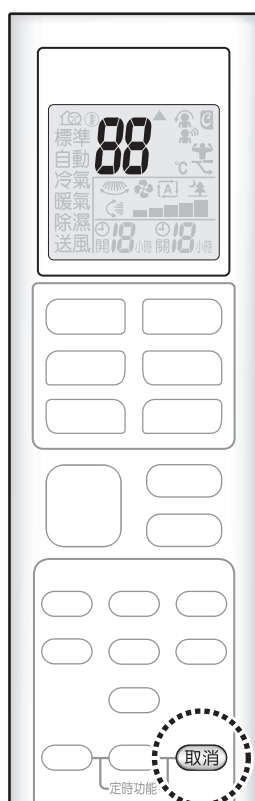

■ Fault diagnosis by remote controller

- In case the air conditioner is malfunctioning, you can check the error code via the remote controller before consulting with service personnel and informing them of the malfunction code.

1. When **取消 is held down for about 5 seconds, “**00**” blinks in the temperature display section.**

2. Press **取消 repeatedly until a long beep is produced.**

- The code indication changes as shown below, and notifies you with a long beep.

	CODE	MEANING
SYSTEM	00	NORMAL
	UA	INDOOR-OUTDOOR UNIT COMBINATION FAULT
	U0	REFRIGERANT SHORTAGE
	U2	DROP VOLTAGE OR MAIN CIRCUIT OVERVOLTAGE
	U4	FAILURE OF TRANSMISSION (BETWEEN INDOOR UNIT AND OUTDOOR UNIT)
INDOOR UNIT	A1	INDOOR PCB DEFECTIVENESS
	A5	FREEZE-UP PROTECTOR
	A6	FAN MOTOR FAULT
	C4	FAULTY HEAT EXCHANGER TEMPERATURE SENSOR
	C9	FAULTY SUCTION AIR TEMPERATURE SENSOR
OUTDOOR UNIT	EA	COOLING-HEATING SWITCHING ERROR
	E1	CIRCUIT BOARD FAULT
	E5	OL STARTED
	E6	FAULTY COMPRESSOR START UP
	E7	DC FAN MOTOR FAULT
	E8	OVERCURRENT INPUT
	F3	HIGH TEMPERATURE DISCHARGE PIPE CONTROL
	F6	HIGH PRESSURE CONTROL (IN COOLING)
	F8	OPERATION HALT DUE TO COMPRESSOR INTERNAL TEMPERATURE ABNORMALITY
	H0	SENSOR FAULT
	H6	OPERATION HALT DUE TO FAULTY POSITION DETECTION SENSOR
	H8	DC CURRENT SENSOR FAULT
	H9	FAULTY SUCTION AIR TEMPERATURE SENSOR
	J3	FAULTY DISCHARGE PIPE TEMPERATURE SENSOR
	J6	FAULTY HEAT EXCHANGER TEMPERATURE SENSOR
	L3	ELECTRICAL PARTS HEAT FAULT
	L4	HIGH TEMPERATURE AT INVERTER CIRCUIT HEATSINK
L5	OUTPUT OVERCURRENT	
P4	FAULTY INVERTER CIRCUIT HEATSINK TEMPERATURE SENSOR	

NOTE

- A short beep and 2 consecutive beeps indicates non-corresponding codes.
- To cancel the code display, hold **取消** down for about 5 seconds. The code display also clears if no button is pressed for 1 minute.

舒適節能全面強化



智慧眼

智慧眼感應器可探測室內人員活動。
如果室內超過 20 分鐘無人，空調機會自動轉入節能模式。

▶第 14 頁



舒適

冷氣及除濕運轉時風向朝上，而暖氣模式時風向朝下。
此功能將防止冷氣或暖氣直接吹到身體。▶第 13 頁

其他功能



省電

本功能透過限制最大耗電量來確保運轉效率。當空調機與其他電器同時使用時，可使用此功能。▶第 17 頁



室外機靜音



室外機靜音運轉可降低室外機噪音。
當您需要為鄰居考慮噪音問題時，該功能非常實用。▶第 18 頁

目錄

運轉前須知

安全注意事項	3
各部位名稱	5
運轉前準備	8

運轉操作

 自動・冷氣・除濕・暖氣・送風 運轉	9
 調節風量	11
 調節風向	12

有用的功能

 舒適運轉	13
 智慧眼運轉	14
 強力運轉	16
 省電運轉	17
 室外機靜音運轉	18
 防黴運轉	19

定時器運轉

 定時開/關機運轉	20
--	----

保養

保養與清潔	22
-------------	----

有需要時

FAQ	26
故障排除	27

規格

產品規格	31
------------	----





防黴



防黴功能對室內機的內部進行除濕，同時提供理想的環境以抑制室內機上黴菌的生成。▶第 19 頁

安全注意事項

	操作本機前請閱讀本說明書中的注意事項。		本裝置中充有 R32。
---	---------------------	---	-------------



- 請將此手冊放在使用者易於取閱處。
- 此處所述的注意事項分為警告和注意兩級。其均包含重要安全資訊。請務必嚴格遵守所有注意事項。

	警告	如不嚴格遵守這些說明可能導致受傷或失去生命。
	注意	如不嚴格遵守這些說明可能導致財產損失或人員受傷，危險程度視具體情況而定。

	嚴格禁止。		請嚴格按指令操作。		務必妥善接地。
---	-------	---	-----------	---	---------

- 閱讀完畢後，請將本手冊保存在需要時可方便隨時取閱的地方。如果將裝置轉讓給新使用者，務必將本手冊一併轉交。

警告

-  除生產商所建議的方法之外，請勿用其他方法加速除霜過程或進行清潔。
-  不得將裝置存放在有持續工作的點火源的房間中（例如：明火、使用中的瓦斯用具或電熱器）。
 - 請勿打孔或點燃。
 - 請注意：冷媒可能是無味的。
 - 確保在地板面積大於 ≥ 1.22 平米的室內安裝、操作及存放本裝置。
* 由於本機種的最大冷媒充填量不到 1.22 公斤，因此無任何最小地板面積限制。
地板表面與裝置底部之間保持 1.8m 或更高的安裝高度。
如果用於安裝裝置的房間的地板面積小於指定的最小值，請將其安裝在通風良好的房間內。
 - 為避免火災、爆炸或受傷，當裝置附近檢測到有害氣體（如可燃性或腐蝕性氣體）時請勿使用。
 - 注意，長時期直接暴露於空調機的冷氣或暖氣，或太涼或太暖的空氣中均有損身體健康。
 - 請勿將棒狀物、手指等異物置於回風口或出風口中。接觸空調機快速運轉的風扇葉可能引起產品損壞或人員受傷。
 - 請勿擅自修理、拆卸、重新安裝或改裝空調機，否則可能引起漏水、電擊或火災危險。
 - 請勿在空調機附近使用易燃噴霧，否則可能引發火災。
 - 安裝、移動或維修時請勿使用除室外機上指定冷媒以外的冷媒（R32）。
使用其他冷媒可能引起機體故障或損壞及人員受傷。
 - 為避免觸電，請勿用濕手操作。

-  冷媒洩漏時謹防火災。如果空調機未正常運轉，如未生成冷氣或暖氣時，即可能是冷媒洩漏所引起。請與您的經銷商聯絡，尋求幫助。空調機所用冷媒是安全的，且一般情況下不會洩漏。然而，發生洩漏時如果接觸敞開的火爐、加熱器或爐具則可能生成有害氣體。在合格的維修人員確認洩漏已修復前請勿使用空調機。
- 請勿嘗試自行安裝或維修空調機。操作不當可能導致漏水、觸電或火災。請聯繫您的當地經銷商或合格的技術人員進行安裝及維修作業。
- 如果空調機出現異常（發出焦味等），請關閉機體電源並聯繫您的當地經銷商。此時再繼續使用可能引起故障、觸電或火災危險。
- 務必安裝漏電保護斷路器。如不安裝漏電保護斷路器可能引起觸電或火災。

-  務必將空調機接地。請勿將機體地接至設施管道、避雷針或電話接地線。接地不好可能導致觸電。

注意

-  除預定用途外，請勿將空調機用於其他用途。請勿將空調機用於冷卻精密儀器、食品、植物、動物或藝術品，否則可能對相關物品的性能、品質及 / 或使用壽命造成負面影響。
- 請勿將植物或動物直接暴露於空調機氣流下，否則可能引起負面影響。
- 請勿將生成明火的裝置放在暴露於空調機氣流的地方，否則可能引起不完全燃燒。
- 請勿擋住回風口或出風口。氣流不暢可能引起性能下降或發生故障。

- ⊘ 請勿坐在室外機上、在機體上放置物體或拉機體。否則可能引起事故，如掉落或倒塌，從而導致受傷、產品功能異常或損壞。
- 請勿將易於受潮的物體直接放在室內機或室外機下方。在某些情況下，主機或冷媒管上的結露、空氣濾網上的灰塵或堵塞的排水可能掉落，弄髒相關物體或使其功能異常。
- 長時期使用後，請檢查機體底座及其固定架有無損壞。如發現損壞而放任不管，則機體可能掉落而引起受傷。
- 為避免受傷，請勿觸碰室內機或室外機的回風口或鋁制鱗片。
- 本裝置不供幼兒及身心虛弱者在無人監護的情況下使用。否則可能損傷身體機能並有損健康。
- 孩童使用時應有人監護以確保其不將機體及其遙控器用於玩耍。孩童無意操作可能引起身體機能及健康受損。
- 避免撞擊室內機和室外機，否則可能導致產品損壞。
- 請勿將易燃物品，如噴霧器，置於出風口 1m 以內。
噴霧器可能因室內機或室外機生成的熱空氣而發生爆炸。
- 小心勿讓寵物在空調機上小便。在空調機上小便可能造成觸電或火災。
- 請勿用水清洗空調機，否則可能引起觸電或火災。
- 請勿將貯水容器（花瓶等）放於機體上方，否則一旦其翻倒則可能引起觸電或火災。
- 電池放入時應避免極性 (+/-) 錯誤，否則可能導致短路、失火或漏液。
- 切勿坐在或懸掛在蓋板上。蓋板可能會掉落，進而導致人身傷害或產品故障。
- 切勿晃動蓋板。蓋板可能擊中人員或物品，進而導致人身傷害或財物損壞。
- 切勿讓兒童在蓋板附近玩耍。可能會導致人身傷害或財物損壞。
- 切勿拉扯電線。電線會損壞，且蓋板可能會掉落，進而造成人身傷害或財物損壞。
- 切勿在行進路線中放置障礙物。蓋板可能掉落，進而導致人身傷害或財物損壞。
- 切勿彎折或損壞電線。電線會損壞，且蓋板可能會掉落，進而造成人身傷害或財物損壞。
- 切勿在蓋板上放置物品，否則會導致產品故障。
- 在操作或維修空調機時，切勿使用不穩定的梯架，否則您可能摔倒或受傷。
- 請將遙控器放置在兒童取不到的地方。錯誤操作遙控器可能會造成受傷。

- ⚠ 在室內同時使用空調機及火爐等設備時，為避免缺氧，請確保房間通風良好。
- 清潔之前，務必停止本機運轉，關閉斷路器，或拔下電源線。
否則可能導致觸電和受傷。
- 請僅將空調連接至指定的電源電路上。非指定電源會導致觸電、過熱或火災。
- 安裝排水管時應確保水能順利排出。排水不完全可能導致房屋、家具等物品受潮。
- 切勿在室外機旁放置物品，也不要讓樹葉及其他碎屑堆積在機器四周。樹葉是小動物的溫床。這些小動物可能會入侵機器內部。接觸到電氣零件，而造成故障、冒煙或火災。
- 不要在室內機附近堆放物品。
因為這樣做可能會對空調機的性能、產品品質和壽命產生不利影響。
- 本電器並未針對肢體、感官或心智能力較弱或缺乏操作知識的人設計。因此，除非其監護人提供監督或指示，否則不宜使用本電器。避免兒童接近，確保他們不會玩耍本電器。

關於室內機及室外機四周空間的注意事項

- 請務必遵照以下說明。
 - 室內機須距離電視機或收音機至少 1m（空調機可能會干擾圖像或聲音）。
 - 避免在容易產生大量油煙的地方使用空調機，例如廚房。否則可能導致漏水。

各部位名稱

室內機

■ FTXV22/28/36

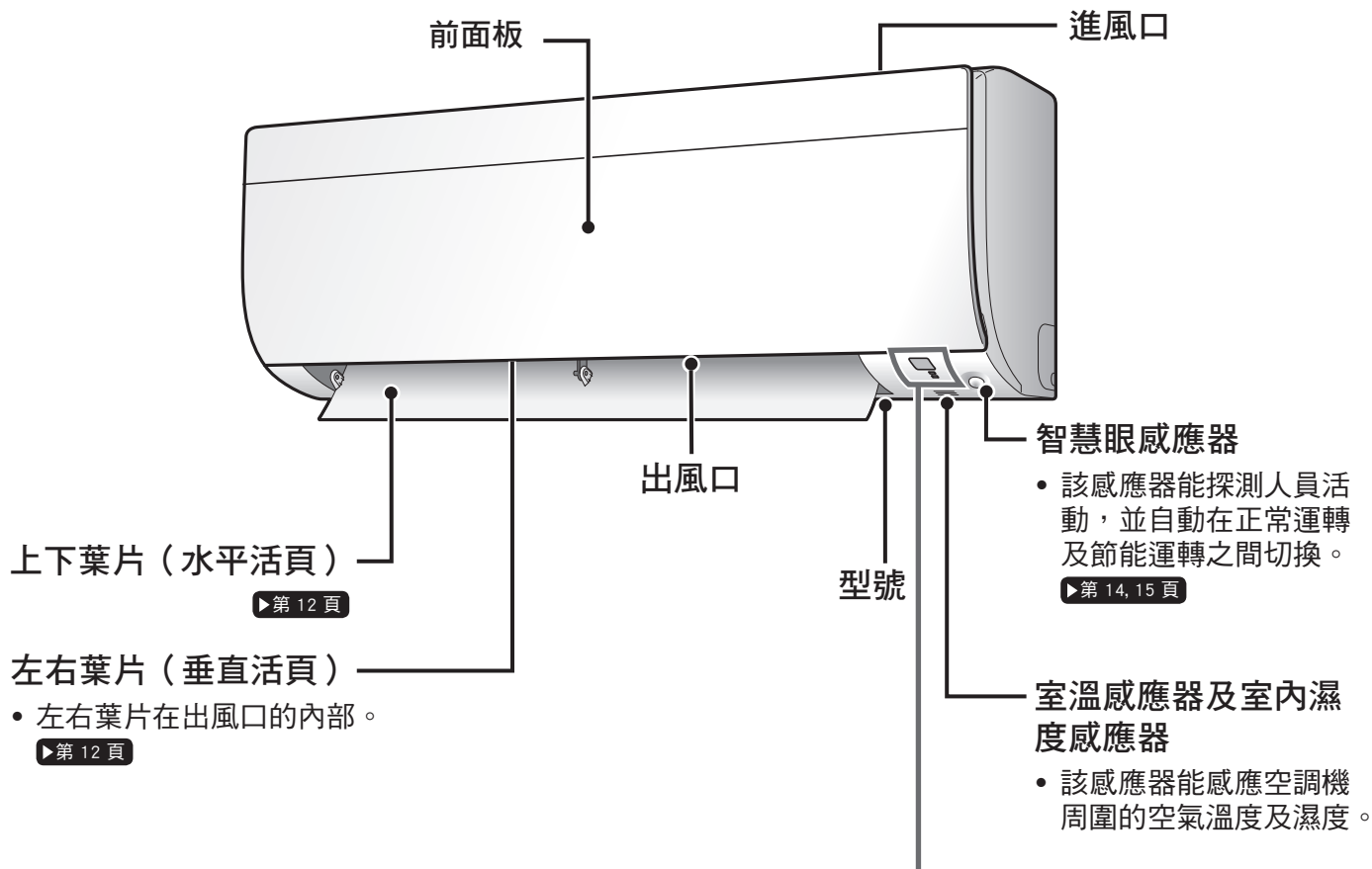

顯示部

訊號接收部位

- 接收來自遙控器的訊號。
- 當空調機接收到訊號時，您會聽到「嗶」聲。

情況	聲音類型
開始運轉	嗶 - 嗶
變更設定	嗶
停止運轉	長嗶聲

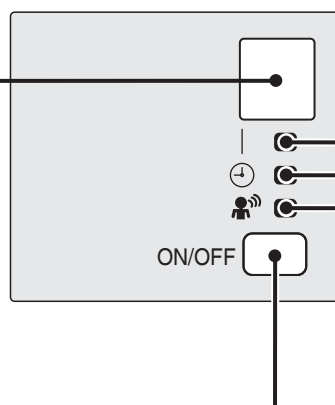

▶第 20, 21 頁

▶第 14 頁

室內機「運轉 / 停止」開關

- 按此開關一次可啟動運轉。再按一次則停止運轉。
- 運轉模式請見下表。

模式	溫度設定	風量
自動	25°C	自動

- 當找不到遙控器或電池沒電時，可使用此開關。

■ 打開前蓋板

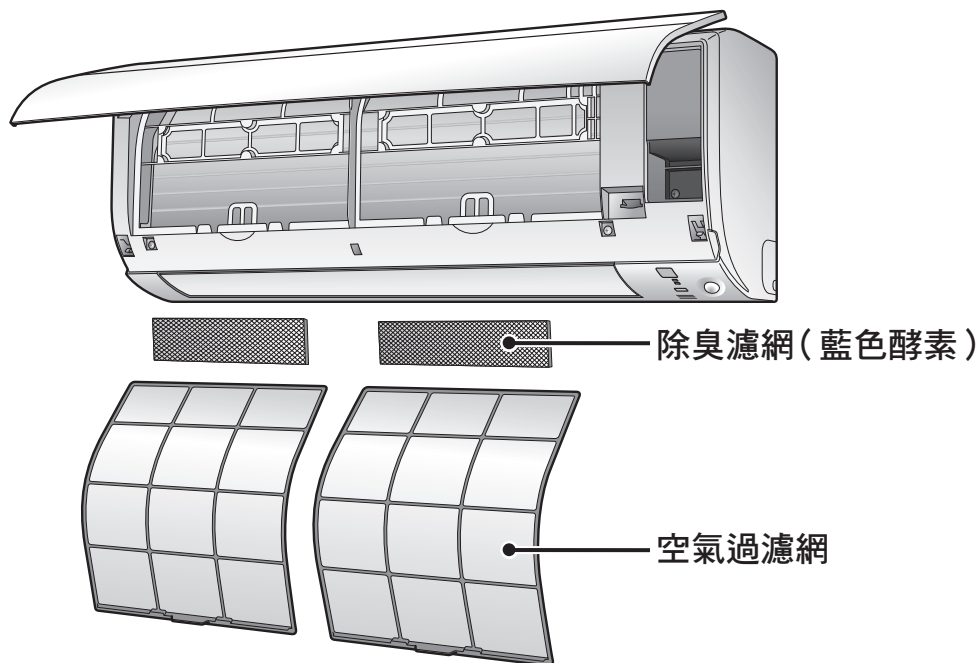

■ 室外機

■ RXV22/28

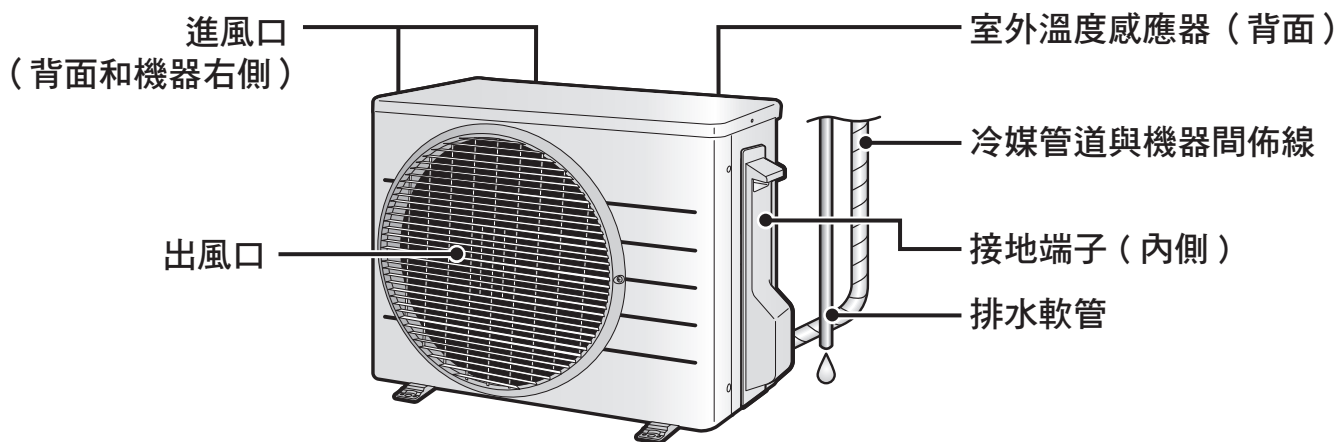

■ RXV36

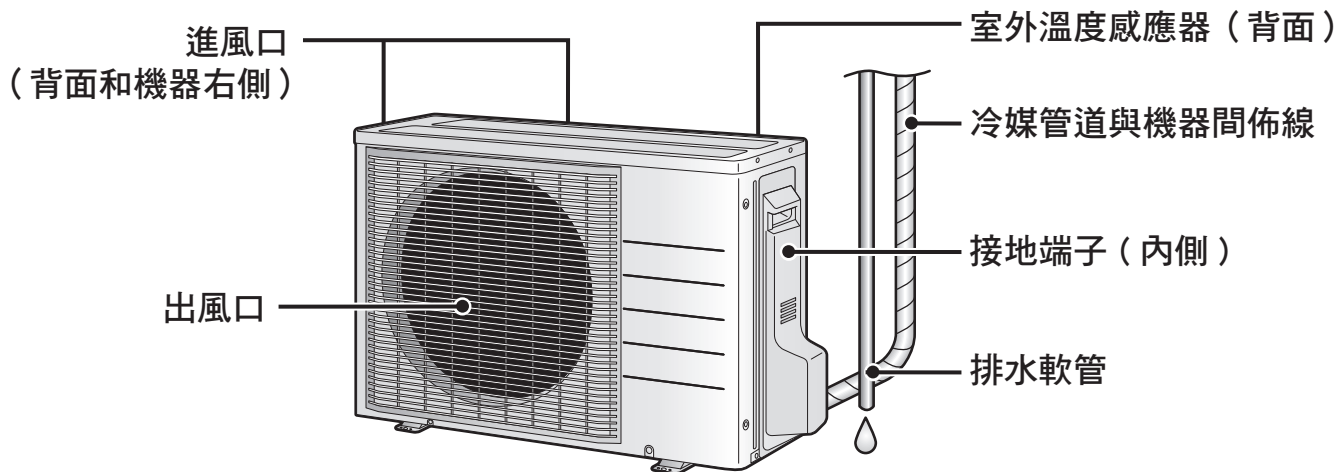

各部位名稱

遙控器

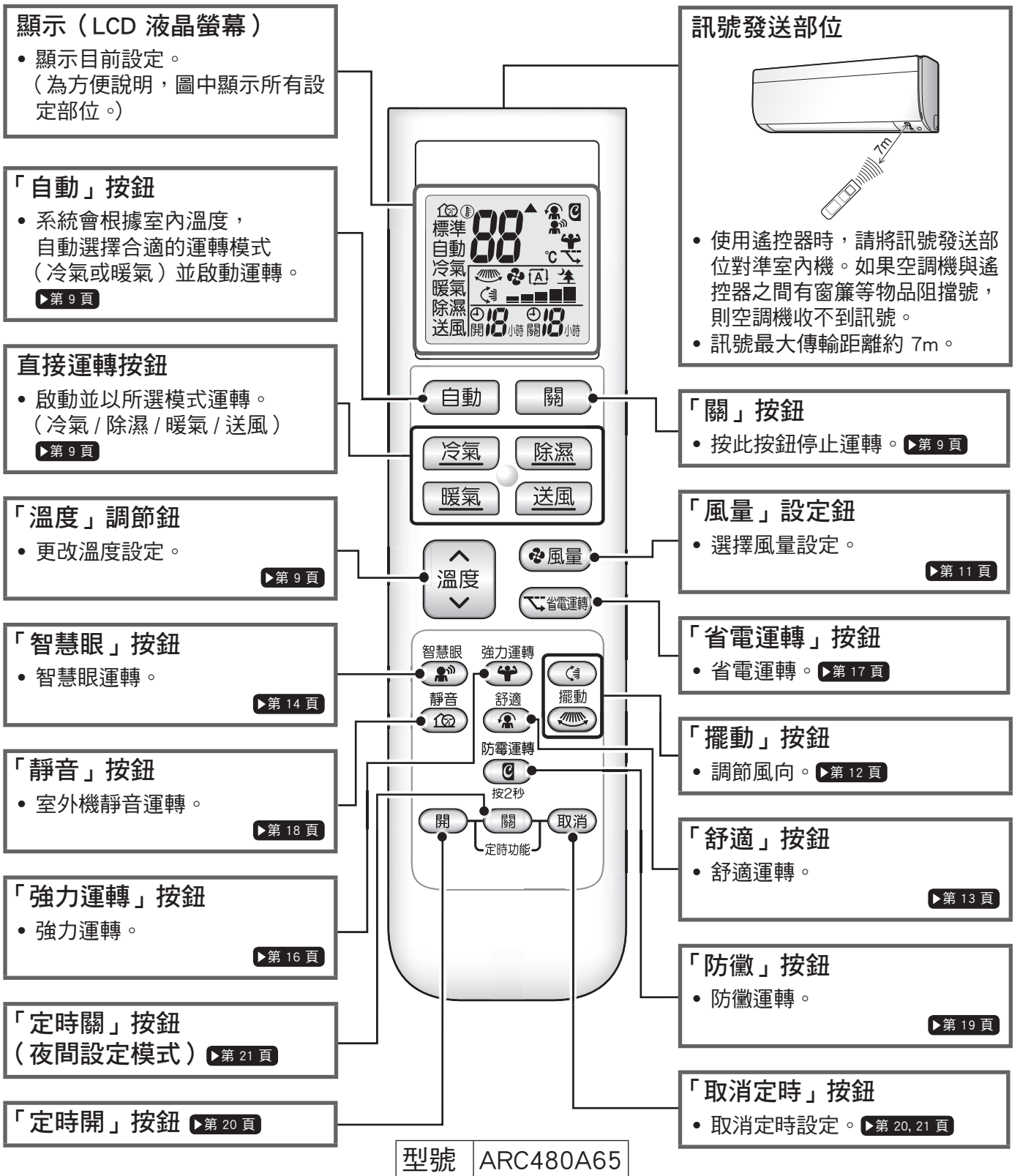

運轉前準備

⚠ 注意

若未正確處理電池，電池可能漏液、破裂或發熱，導致人員受傷或設備故障。

請遵守以下注意事項，確保使用安全。

- 萬一鹼性溶液不慎進入眼睛，切勿搓揉。請立刻用自來水沖洗眼睛，然後儘速就醫。
- 將電池存放在兒童無法取得之處。若不慎吞入電池，應立刻就醫。
- 切勿讓電池暴露於高溫或火源下。切勿拆解或改造電池。電池內的絕緣體或排氣孔可能受損，導致電池漏液、破裂或發熱。
- 切勿損毀或剝除電池表面的標籤。

■ 安裝電池

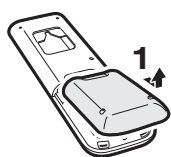

滑動後蓋，將其取下。

注意 ⊕ 和 ⊖ 位置要正確！

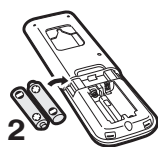

裝入 2 顆 AAA.LR03 乾電池（鹼性）。

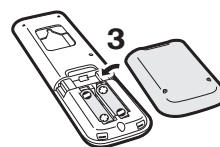

按原狀裝回後蓋。

■ 將遙控器架固定在牆上

1. 選擇一個訊號能夠傳送到空調機的地方。
2. 使用配件組中的螺絲將支架固定到牆壁、柱子或類似位置上。
3. 將遙控器放置在遙控器架上。

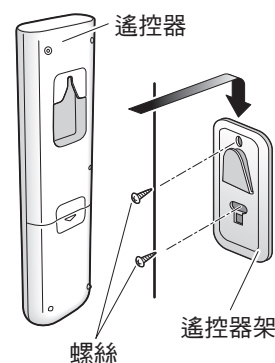

■ 安裝除臭濾網（藍色酵素）

- 若要安裝選購濾網，請在開啟電源之前安裝妥當。▶ 第 24 頁

■ 開啟斷路器

- 當電源開啟時，室內機的上下葉片會開關一次以設定參考位置。

註

關於電池的注意事項

- 為避免電池漏液或破裂而導致受傷或損害，當產品長期不用時，請將電池取出。
- 標準更換時間為 1 年。兩顆電池應同時更換。更換時，請務必使用全新的四號 AAA LR03（鹼性）電池。
- 當電池沒電時，LCD 顯示幕會開始閃爍，提醒需要更換電池。在某些情況下，若電池因使用狀況而加速耗電，在 LCD 開始閃爍之前，訊號接收可能已減弱。
- 遙控器附帶的電池僅供初期使用。該電池使用壽命可能小於 1 年。

關於遙控器的注意事項

- 請勿將遙控器掉落。請勿弄濕遙控器。
- 訊號發送器或接收器上有灰塵會降低靈敏度。請用軟布擦去灰塵。
- 如果室內裝有使用電子啟動器的日光燈（如變流器型燈），訊號傳輸可能失效。如果發生這種情況，請洽服務站。
- 如果空調遙控器剛好操作到其他電器，請將該電器移到其他位置，或洽服務站。



自動 · 冷氣 · 除濕 · 暖氣 · 送風運轉

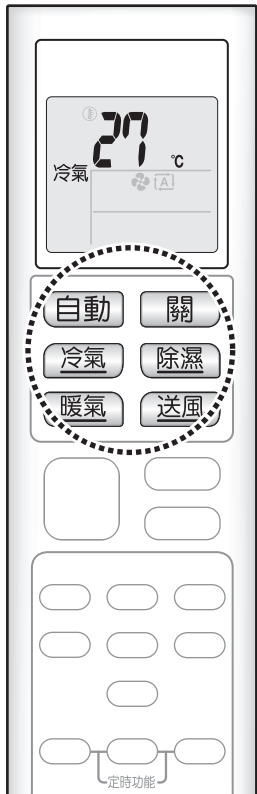

空調機是以使用者選擇的模式運轉。

■ 啟動運轉

● 按下您想要的運轉模式按鈕。

自動運轉

按 **自動**。「自動」出現在 LCD 液晶顯示幕上。

冷氣運轉

按 **冷氣**。「冷氣」出現在 LCD 液晶顯示幕上。

除濕運轉

按 **除濕**。「除濕」出現在 LCD 液晶顯示幕上。

暖氣運轉

按 **暖氣**。「暖氣」出現在 LCD 液晶顯示幕上。

送風運轉

按 **送風**。「送風」出現在 LCD 液晶顯示幕上。

- 運轉指示燈亮綠色。

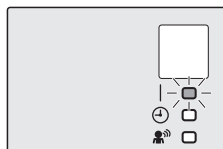

顯示

- 當空調機運轉時，可按下你想要的運轉模式鈕，切換運轉模式。

■ 停止運轉

● 按 **關**。

- 運轉指示燈熄滅。

註

自動運轉備註事項

- 在自動運轉時，系統根據室內與室外溫度選擇合適的運轉模式（冷氣或暖氣）並啟動運轉。
- 系統每隔一段固定時間會自動重新選擇設定，以使室內溫度達到使用者設定的溫度。

冷氣運轉備註事項

- 本空調產品是透過將室內熱量釋放至室外實現房間降溫的。因此，如果室外溫度較高，空調的降溫效果會降低。

除濕運轉備註事項

- 在除濕模式下，室內溫度會儘量保持不變。此時，溫度及風速為自動控制，無法手動調整。

暖氣運轉備註事項

- 由於本空調產品是透過從室外空氣中吸收熱量來提高室溫的，因此當室外溫度較低時，暖氣功能就會變弱。如果暖氣效果不夠，建議您使用其他的供暖設備與空調配合。
- 熱力泵系統透過使熱空氣在房間內的各個部份循環來為房間升溫。在啟動暖氣運轉之後，房間需要一定的時間變暖。
- 在暖氣運轉過程中，室外機可能會結霜，從而減弱暖氣功能。在這種情況下，系統會切換至除霜運轉來進行除霜。

送風運轉備註事項

- 該模式僅對風扇有效。

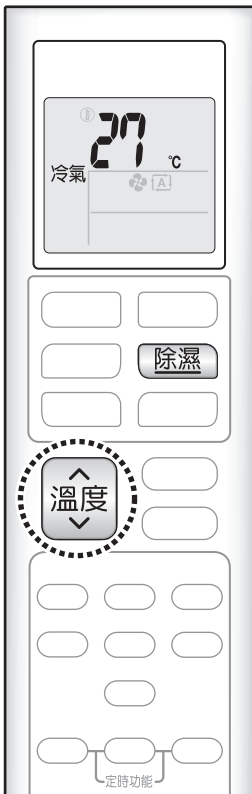

■ 變更溫度設定

● 按  。

- 按 \wedge 可提高溫度，按 \vee 可降低溫度。
每按一下按鈕，溫度改變 1°C。

冷氣運轉	暖氣運轉	自動運轉	除濕運轉	送風運轉
18~32°C	10~30°C	18~30°C	"STD ~ (STD - 3°C)" *1,*2	無法使用溫度設定。

*1 STD (標準).... 除濕運轉時的室內溫度為標準。

*2 STD (標準).... LCD 螢幕上顯示「除濕」及「標準」。

[除濕]

■ 使用除濕模式

● 按下「」並選擇除濕運轉模式。

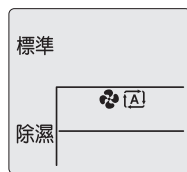

- LCD 螢幕上顯示「除濕」及「標準」。
- 除濕運轉模式啟動。

- 按下  可提高溫度，按下  可降低溫度；每按一下會提高或降低 1°C。

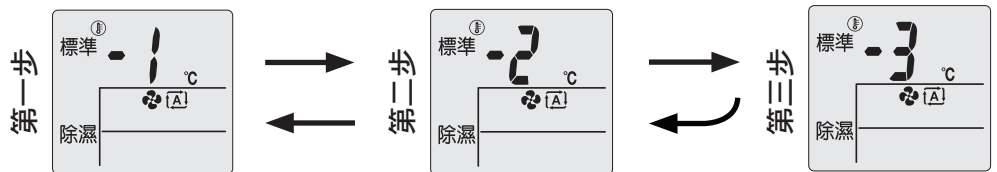

- 該模式混合除濕後的冷空氣與室內空氣，以調整出風口溫度並除去濕氣。
- 當室內溫度上升時，會自動啟動冷氣運轉。
- 當室外溫度低於室內溫度時，除濕效果較差。
- 為了降低濕度，除濕運轉的風速會自動控制。



調節風量





您可調節風量來提高舒適度。

■ 調節風量設定

● 按 。

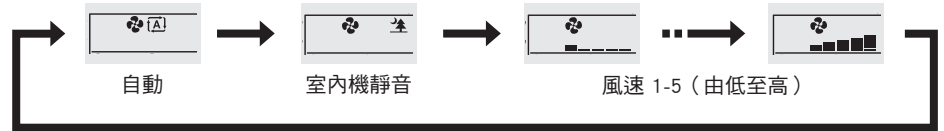
- 每按一下  可依下列順序改變風量。



- 當風量被設定為「」時，將啟動室內機靜音運轉，則空調機產生的噪音就會變小。
- 在室內機靜音運轉時，風速會設為弱。
- 若冷氣 / 除濕運轉一開始的風速設定為「自動」，則室內機會先除臭，抑制內部任何異味。因此，室內機不會立刻出風。(請稍待約 1 分鐘。)
- 當風量較小時，冷氣 (暖氣) 效果也會較弱。

節能小常識

溫度設定適中有助於節能。

- 建議的溫度設定
 - 冷氣模式：26-28°C
 - 暖氣模式：20-24°C

用百葉窗或窗簾遮掩窗戶。

- 防止陽光及空氣進入室內可加強冷房 (暖房) 效果。

保持空氣濾網乾淨。

- 空氣濾網阻塞會造成低效運轉及能源浪費。請大約每 2 週清洗一次。▶第 23 頁

若長時間不用空調 (例如春季或秋季)，請關閉斷路器。

- 即使不運轉，空調機也會持續消耗少許電力。



調節風向

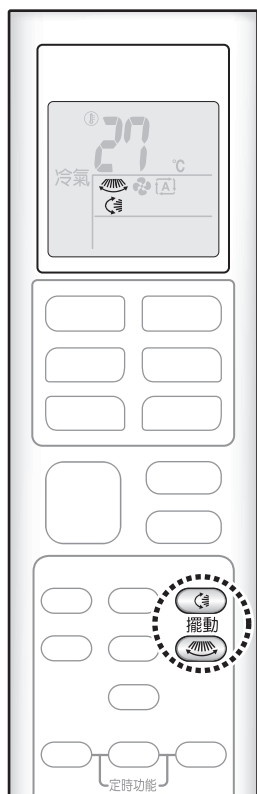



您可調節風向來提高舒適度。

⚠ 注意

- 請務必使用遙控器來調節上下葉片與左右葉片的角度。
 - 如果在上下葉片與左右葉片擺動時嘗試用手移動葉片，機械裝置可能會損壞。
 - 在出風口內部有風扇正以高速旋轉。



■ 開始自動擺動

上風向與下風向

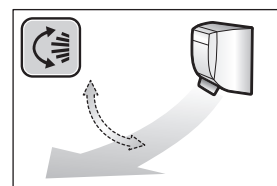
- 按 。
 - 「」出現在 LCD 液晶顯示幕上。
 - 上下葉片（水平活頁）將開始擺動。



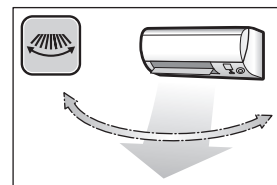

右風向與左風向

- 按 。
 - 「」出現在 LCD 液晶顯示幕上。
 - 左右葉片（垂直活頁）將開始擺動。





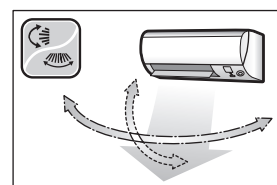

3D 立體風向

- 按下  與 。
 - 「」與「」出現在 LCD 液晶顯示幕上。
 - 上下葉片與左右葉片將輪流擺動。
 - 如需取消 3D 立體風，再按一次  或  即可。上下葉片或左右葉片將停止擺動。



■ 將上下葉片或左右葉片設定在您想要的位置

- 此功能在上下葉片或左右葉片處於自動擺動模式時有效。
- 當上下葉片或左右葉片到達您希望的位置時，按下  與 。
 - 在 3D 立體風運轉時，上下葉片與左右葉片會輪流擺動。
 - 「」或「」從 LCD 液晶顯示幕上消失。

註

關於風向設定的注意事項

- 上下葉片的活動幅度因運轉模式而異。

關於 3D 立體風定的注意事項

- 由於冷空氣會向房間底部集中，而熱空氣會向天花板集中，因此可使用 3D 立體風來循環冷空氣和熱空氣，以避免房內部分區域過冷和過熱。

上下葉片的活動幅度

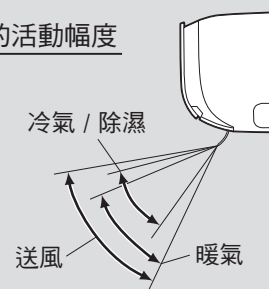



舒適運轉

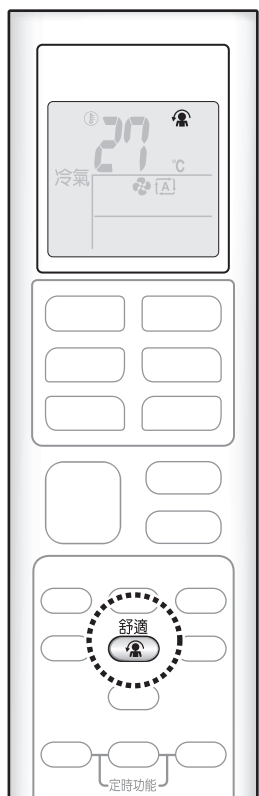

在冷氣運轉中，風向將會向上，而在暖氣運轉中，風向則會向下，這樣就能實現一種不會直吹人體的舒適風。

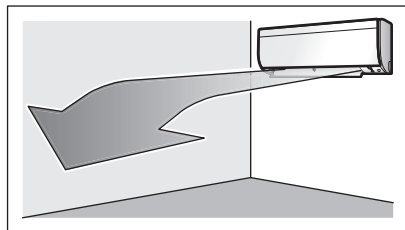

冷氣運轉

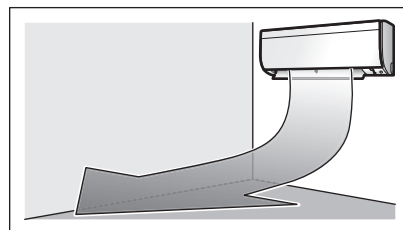

暖氣運轉

■ 開始

● 按 。

- 「」出現在 LCD 液晶顯示幕上。

	冷氣及除濕運轉	暖氣運轉	送風運轉
導風葉方向	向上	向下	不可用
風量	自動		

■ 取消

● 再按一下  按鈕。

- 「」從 LCD 液晶顯示幕上消失。
- 側翼將從之前的「舒適」模式返回到存儲位置。

註

有關舒適運轉的注意事項

- 側翼位置將改變，防止空氣直接吹到室內居住者的身上。
- 不能同時進行強力運轉和舒適運轉。
- 風量將設為自動。若選擇上吹或下吹風向，則會取消舒適風功能。哪一個按鈕最後被按下，就會對相對應的功能給予優先權。



智慧眼運轉

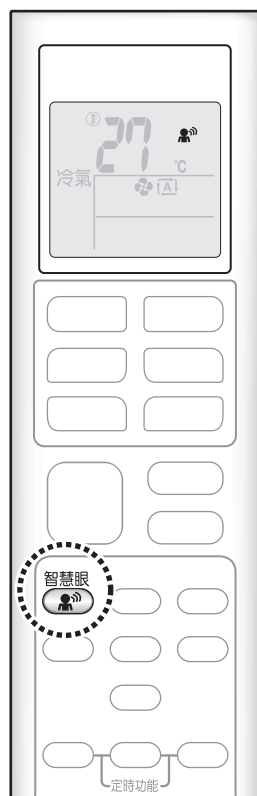

「智慧眼」是紅外線感應器，能探測人員活動。
如果室內超過 20 分鐘無人，空調機會自動轉入節能模式。

⚠ 注意

- 請勿在感應器附近放置大型物體。此外，請將暖爐及增濕器移出感應器探測區域。感應器可能會探測到意料之外的物體。
- 切勿撞擊或猛推智慧眼感應器。這會導致損壞和故障。

■ 開始

▶ 按 ^{智慧眼} 。

- 「」出現在 LCD 液晶顯示幕上。
- 智慧眼指示燈亮綠色。
- 當探測到人員活動時，指示燈將亮起。

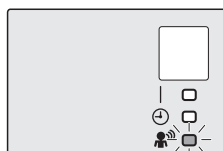

顯示

■ 取消

▶ 再按一下 ^{智慧眼} 按鈕。

- 智慧眼指示燈熄滅。



智慧眼運轉

註

節能運轉

- 如果室內 20 分鐘探測不到人員活動，節能運轉將啟動，「智慧眼」燈號熄滅。
如果再次探測到人員活動，「智慧眼」燈號將亮起，結束節能運轉。
- 此運轉模式會將溫度從設定溫度更改為：暖氣降低 2°C / 冷氣升高 2°C / 除濕升高 2°C。
當室溫超過 30°C 時，此運轉模式會將溫度從設定溫度更改為：冷氣升高 1°C / 除濕升高 1°C。
- 在送風運轉時，此運轉模式僅略微降低風量。

關於智慧眼運轉的注意事項

- 適用範圍如下。

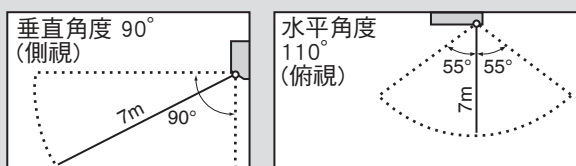

- 即使這個區域中有人，空調也可能進入節能模式。
如果區域中人員不動，則可能發生這種情況，實際取決於人員所穿衣物的顏色。
- 由於感應器所在位置，如果人員靠近室內機正面，可能會暴露在室內機吹出的氣流之下。
- 感應器也可能將寵物、陽光、飄動的窗簾和鏡子反射的光線等誤認為經過的人員。
- 感應器可能不會探測到 7m 以外的移動物體。(請參閱適用範圍。)
- 感應器靈敏度會因室內機位置、人員經過速度、溫度範圍等因素而改變。
- 夜間設定模式 [▶第 21 頁](#) 在使用智慧眼運轉時將停止運作。

強力運轉

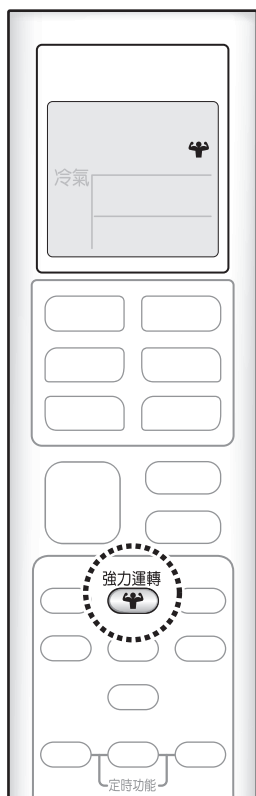

在任何運轉模式下，強力運轉都會迅速將冷氣（暖氣）效果提升到最大。您可以達到最大空調能力。

■ 開始

在運轉時按下  。

- 「」出現在 LCD 液晶顯示幕上。
- 強力運轉會在 20 分鐘後結束。此時，系統會自動切回強力運轉之前的運轉設定。



■ 取消

再按一下  按鈕。

- 「」從 LCD 液晶顯示幕上消失。

註

關於強力運轉的注意事項

- 按  會取消設定，而「」會從 LCD 液晶顯示幕上消失。
- 如果空調已經以其經過驗證的最大能力運轉，強力運轉將不會提高空調能力。
 - 在冷氣與暖氣運轉中
為了最大限度地提高冷氣（暖氣）效果，室外機的能力被增大，風量被定為最高設置。溫度與風量設定不可改變。
 - 在除濕運轉中
溫度設定被降低 2.5°C，而風量被略微提高。
 - 在送風運轉中
風量將被定為最高設置。

關於「功能強大」和其他運轉的結合

「功能強大」+「舒適的風量」	無法使用*
「功能強大」+「節能」	
「功能強大」+「室外機靜音」	



* 哪一個按鈕最後被按下，就會對相對應的功能給予優先權。

省電運轉



省電運轉是一種透過限制耗電量最大值、實現高效運轉的功能。當此產品與其他電器同時運作時，有時需要特別注意以確保電路斷路器不會跳閘，在這種情況下，節能運轉功能非常有用。

■ 開始



- 按 。
- 「」出現在 LCD 液晶顯示幕上。
- 在送風模式下無法使用。

■ 取消

- 再按一下  按鈕。
- 「」從 LCD 液晶顯示幕上消失。

註

關於省電運轉的注意事項

- 本模式以較低功率運作，因此可能無法提供充分的冷氣（暖氣）效果。
- 按下  會取消設定，而「」會從 LCD 液晶顯示幕上消失。
- 如果耗電量水平已經很低，省電模式將不會降低耗電量。

「省電」運轉和基本運轉的可能組合

省電	運轉模式				
	自動	除濕	冷氣	暖氣	送風
	√	√	√	√	-

可同步使用一些實用功能。

「舒適的風量」+「省電」	可用
「室外機靜音」+「省電」	

室外機靜音運轉

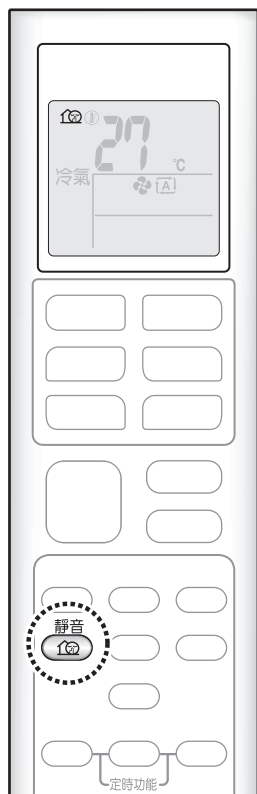

室外機靜音運轉透過改變室外機的頻率與風扇速率來降低室外機的噪音強度。此功能在夜間操作時更為方便。

■ 開始

- 按  。
- 「」出現在 LCD 液晶顯示幕上。

■ 取消

- 再按一下  按鈕。
- 「」從 LCD 液晶顯示幕上消失。

註

關於室外機靜音運轉的注意事項

- 強力運轉與室外機靜音運轉模式不能同時使用。
最後按下的按鈕具有優先權。
- 在使用室外機靜音運轉模式時，即使使用遙控器或室內機開關停止空調機運轉，遙控器顯示幕上仍將顯示「」。
- 如果頻率與風扇速率已降得夠低，室外機靜音運轉不會再降低頻率或風扇速率。

「室外機靜音」運轉和基本運轉的可能組合

室外機靜音	運轉模式				
	自動	除濕	冷氣	暖氣	送風
	√	-	√	√	-

防霉運轉



防霉運轉利用送風來降低室內機內部濕度，防止黴菌散播。

[自動運轉]

■ 開始

● 長按  2 秒。

- 「」出現在 LCD 液晶顯示幕上。

■ 取消

● 再次長按  2 秒。

- 「」從 LCD 液晶顯示幕上消失。

[手動運轉]

● 當室內機未運轉時，按下  約 2 秒。

- LCD 顯示幕閃爍「」，過了一會後恢復正常。

註

防霉運轉備註事項

- 若要中途停止防霉運轉，請按 。
- 當除濕或冷氣運轉停止後，空調機會自動啟動防霉運轉，並且在 60 分鐘後自動停止。
- 本功能並不能去除已經存在的灰塵或黴菌。
- 當空調機使用「定時關」功能關機時，無法進行防霉運轉。



定時開 / 關機運轉

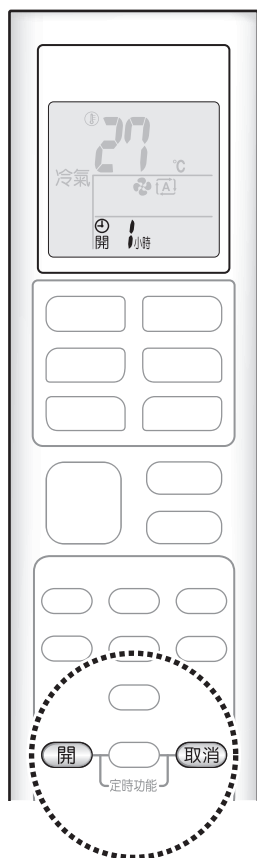

定時功能對於在夜間或早上自動開關空調非常有用。您可以將「定時關閉」與「定時開啟」功能配合使用。

[定時開機運轉]

■ 設定

● 按 **開** 。

「」出現在 LCD 液晶顯示幕上。

- 每按一次 **開** 可將時間設定變更 1 小時。
時間設定範圍為 1 至 12 小時。
- 定時指示燈亮橘色。

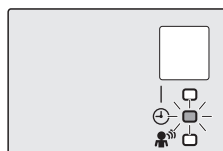

顯示

■ 取消

● 按 **取消** 。

- 「」從 LCD 液晶顯示幕上消失。
- 定時指示燈熄滅。

註

出現以下情況時，請重設定時功能。

- 關閉斷路器後。
- 停電後。
- 更換遙控器電池後。

開 關 定時開 / 關機運轉

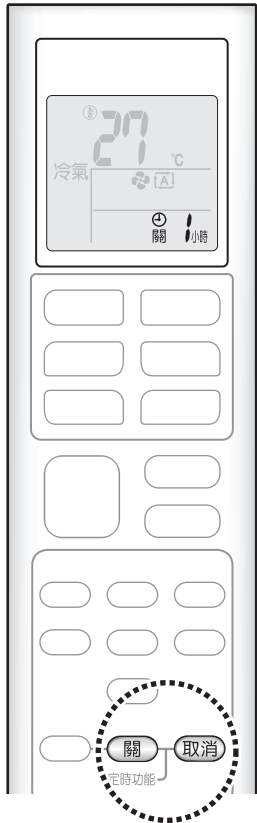

[定時關機運轉]

■ 設定

● 按 **關**。



「**關 1小時**」出現在 LCD 液晶顯示幕上。

- 每按一次 **關** 可將時間設定變更 1 小時。
時間設定範圍為 1 至 12 小時。
- 定時指示燈亮橘色。

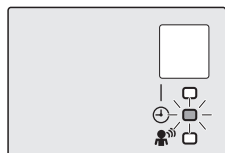

顯示

■ 取消

● 按 **取消**。

- 「**關 1小時**」從 LCD 液晶顯示幕上消失。
- 定時指示燈熄滅。

[定時開 / 關組合]

■ 組合

- 以下為兩種定時器搭配使用的設定範例。
- 「開」與「關」出現在 LCD 液晶顯示幕上。

[範例]



在空調機運轉時進行設定。

- 1 小時後關機，再過 7 小時開機。



在空調機停止時進行設定。

- 2 小時後關機，再過 3 小時開機。

註

夜間設定模式

- 設定好定時關機後，空調機會自動調節溫度設定（冷氣運轉模式調高 0.5°C，暖氣運轉模式調低 2.0°C），以防止溫度過冷（過熱），確保您睡得舒適。

保養與清潔

⚠ 注意

- 在清潔前，請確保使空調停止運轉，並關閉斷路器。
- 請勿觸摸室內機的鋁散熱片。如果您觸碰了這些部件，可能會造成人身傷害。

■ 快速參考

清潔部件

前蓋板

- 用浸濕的軟布擦拭。
- 只能使用中性洗劑。

如有污垢



空氣過濾網

- 真空除塵或清洗過濾網。

每 2 周一次

▶ 第 23 頁

室內機，室外機與遙控器

- 用軟布擦拭。

如有污垢

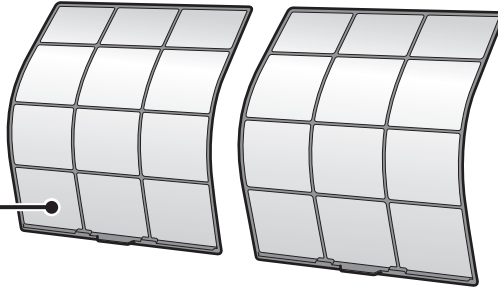
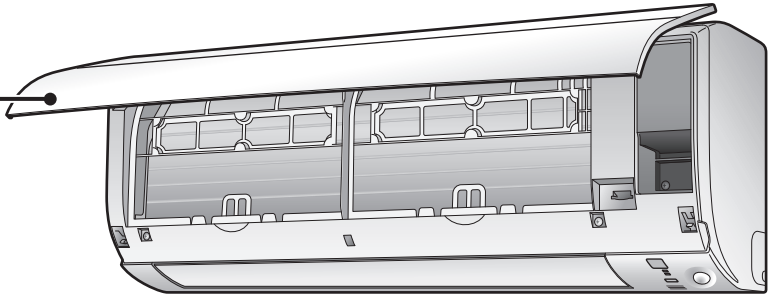

除臭濾網（藍色酵素）

如需購買下列濾網（表 1）或另一種濾網，請洽原經銷商。不同型號的濾網，可能有不同的清潔及更換方式。請參照選購配件上的標籤說明。

表 1

訂購項目	零件編號
除臭濾網（藍色酵素）- 無邊框（一組 2 片）	BAFP094A41
集塵濾網 (PM 2.5) - 無邊框（一組 2 片）	BAFP046A41
鈦磷灰石除臭過濾網 - 無邊框（一組 2 片）	KAF970A46

除臭濾網（藍色酵素）、鈦磷灰石除臭過濾網

- 真空除塵或更換過濾網。

[清潔]

每 6 個月一次

▶ 第 24 頁

[更換]

每 3 年一次

▶ 第 24 頁

集塵濾網 (PM 2.5)

- 無需清潔。每 6 個月請更換一次濾網。▶ 第 24 頁

註

清潔時，請勿使用以下東西：

- 溫度超過 40°C 的水
- 輕質汽油、汽油、稀釋劑等揮發性油。
- 拋光劑。
- 粗糙材質，例如刷子。



保養與清潔

⚠ 注意

- 請勿觸摸室內機的鋁散熱片。如果您觸碰了這些部件，可能會造成人身傷害。

■ 空氣過濾網

1. 打開前蓋板。

- 抓住前蓋板兩側，將蓋板打開。

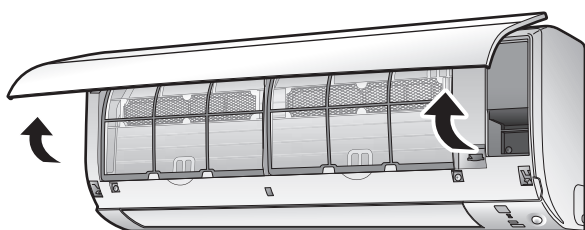

2. 拉出空氣過濾網。

- 將每個空氣過濾網中央的過濾網凸起部略向上推，然後拉下來。

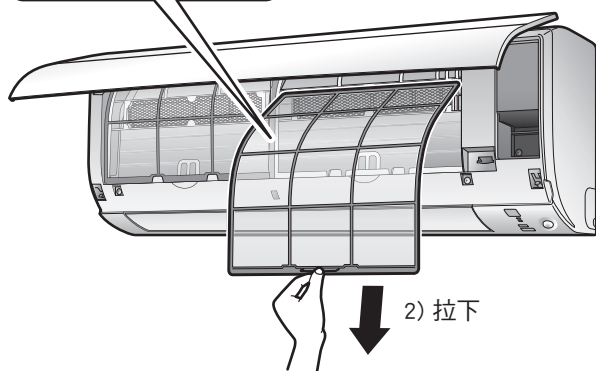
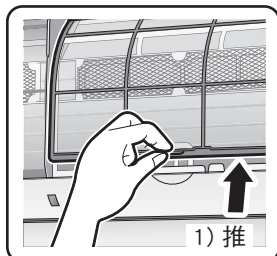

3. 用清水沖洗空氣過濾網，或用真空吸塵器進行清理。

- 建議您每 2 周清理一次空氣過濾網。

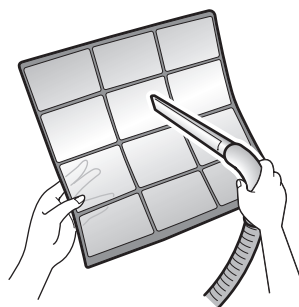

如果灰塵難以脫落

- 請用經溫水稀釋的中性洗滌劑清洗空氣過濾網，然後放在陰涼處風乾。



4. 裝回濾網。

5. 慢慢關閉前蓋板。

- 按下前蓋板兩側與中間部位。

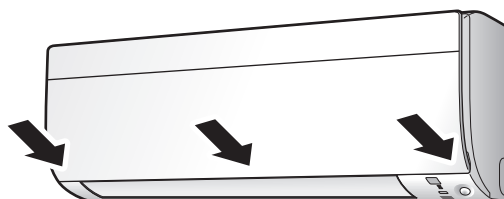

- 務必將前蓋板確實蓋好。

■ 濾網 (小)

* 關於適用的濾網種類，請見 **▶第 22 頁**。

安裝

1. 打開前面板，並拉出空氣濾網。

▶第 23 頁

2. 插入過濾器。

- 檢查過濾器是否固定在卡榫底下。

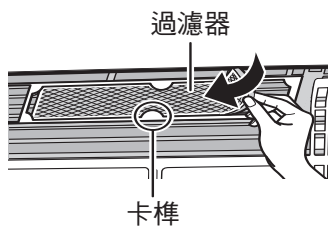

清潔與更換

1. 打開前面板，並拉出空氣濾網。

▶第 23 頁

2. 拆下過濾器。

- 將濾網從擋片上拆下。

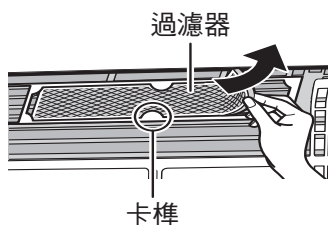

3. 清潔或更換。

[清潔]

● 除臭濾網 (藍色酵素): 藍色 - 黑色 / 安裝鈦磷灰石除臭過濾器: 藍色 - 黑色

3-1 用吸塵器吸塵，如果髒污嚴重，請將其在溫水或清水中浸泡約 10 到 15 分鐘。

3-2 清洗後，請甩掉留下的水分，並在陰暗處晾乾。

- 本濾網建議每 6 個月用水清洗一次，並且每 3 年更換一次。
- 請不要擰絞過濾網，來除去水分。

● 集塵濾網 (PM 2.5): 白色

- 不要清洗濾網，以免降低過濾效率。
- 建議每 6 個月更換一次。

[更換]

將每片濾網從前格柵上拆下 (各 6 個卡榫)，然後安裝新的濾網。

- 裝上過濾網時，請檢查過濾網是否卡進凸起部中。

4. 按照原樣裝回濾網，並關上前蓋板。

- 壓下前蓋板兩側和中間處。

註

- 使用臟過濾網運轉空調會導致：
 - 無法對空氣除臭，
 - 無法清潔空氣，
 - 升溫或降溫效果差，
 - 產生異味，
- 請將舊濾網作為非可燃性廢棄物處理。

保養與清潔

■ 長時間不用之前

1. 以防霉模式運轉。▶第 19 頁
2. 運轉停止後，為空調關閉斷路器。
3. 清潔空氣過濾網並安裝至原位。▶第 23 頁
4. 為避免電池漏液，請將電池從遙控器內取出。

■ 我們建議您定期維護

- 在某些運轉條件下，空調內部會在使用數季之後擠滿灰塵，從而導致性能變差。除了由用戶進行定期清潔以外，我們還建議由專業人員進行定期保養。
- 如需專業人員保養，請聯絡您購買空調的服務提供商洽詢。
- 維護成本須由用戶承擔。

FAQ

室內機

上下葉片沒有立即開始擺動。

- 空調正在調整上下葉片的位置。
上下葉片很快就會開始擺動。

空調機在暖氣運轉中停止產生氣流。

- 一旦達到設定溫度，氣流速率會降低並停止運轉，以避免產生涼爽的氣流。當室內溫度下降時，運轉將會自動恢復。

暖氣運轉突然停止，並且聽到流水的聲音。

- 室外機正在除霜。暖氣運轉會在室外機上的霜被除淨後啟動。
您需要等待約 4 到 12 分鐘。

運轉沒有很快啟動。

- 當運轉停止後不久，即按下 **自動** 或任何直接運轉按鈕時。
- 重新選擇模式時。
 - 這是為了保護空調。
您需要等待約 3 分鐘。

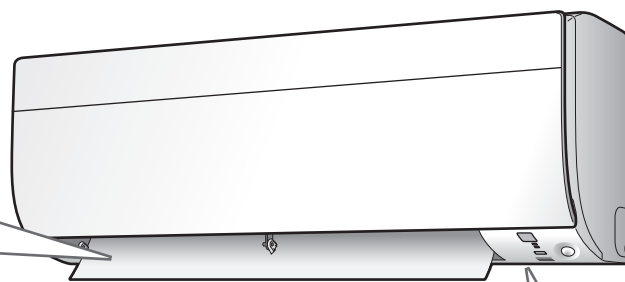

聽到不同的聲音。

- 像流水的聲音
 - 這種聲音是因空調中的冷媒流動而產生。
 - 這是空調中的抽水聲，出現在冷氣或除濕運轉從空調中抽水的時候。
- 呼呼聲
 - 這種聲音出現在空調中的冷媒流動方向轉變時。
- 嘀嗒聲
 - 這種聲音出現在空調機的機櫃與框架因溫度變化而稍有熱漲冷縮時。
- 呼嘯聲
 - 這種聲音出現在除霜運轉模式期間冷媒流動時。
- 在運轉或閒置期間的喀嚓聲
 - 這種聲音出現在冷媒控制閥或電氣部件運轉時。
- 噠噠聲
 - 這種聲音出現於空調內部，出現在室內關閉房門啟用排風扇時。請打開窗或關閉排風扇。

室外機

室外機排水或水蒸氣。

- 在暖氣運轉中
 - 當空調進行除霜運轉時，室外機上的霜會融化成水或水蒸氣。
- 在冷氣或除濕運轉中
 - 空氣中的水分會在室外機管道冰冷的表面的上凝結，並導致滴水。

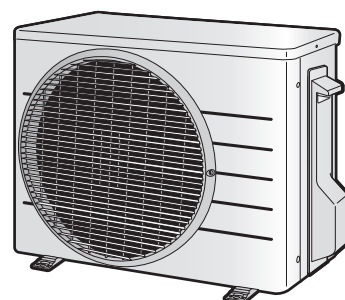

* 根據機種的不同，室外機的外觀有可能不同。

故障排除

在詢問或請求維修之前，請檢查以下事項。
如果問題仍然存在，請諮詢您的經銷商。



非故障
這些情況並非故障。



檢查
請求修理前，請再次檢查。

空調機未運轉。

情況	描述 / 檢查事項
運轉指示燈熄滅。	<ul style="list-style-type: none"> 斷路器跳閘或保險絲熔斷？ 是否停電？ 遙控器中是否已安裝電池？
運轉指示燈閃爍。	<ul style="list-style-type: none"> 關閉含斷路器的電源，然後使用遙控器重新啟動。如果運轉指示燈仍在閃爍，檢查錯誤代碼，並諮詢您的經銷商。

▶ 第 30 頁

空調突然停止運轉。

情況	描述 / 檢查事項
運轉指示燈亮。	<ul style="list-style-type: none"> 為保護系統，空調可能會在發生大的電壓波動時停止運轉。空調會在約 3 分鐘內恢復運轉。
運轉指示燈閃爍。	<ul style="list-style-type: none"> 空氣濾網是否骯髒？請清潔空氣濾網。 室內機與室外機的回風口與出風口是否有異物堵塞？請停止運轉，並關閉斷路器後，清除障礙物。然後使用遙控器重新啟動。如果運轉指示燈仍在閃爍，檢查錯誤代碼，並諮詢您的經銷商。

▶ 第 30 頁

空調未停止運轉。

情況	描述 / 檢查事項
在停止運轉後，空調機卻繼續運轉。	<ul style="list-style-type: none"> 空調機被停止運轉後 <ul style="list-style-type: none"> 室外機風扇仍然會繼續旋轉大約 1 分鐘，以保護系統。 空調未處於運轉狀態時 <ul style="list-style-type: none"> 當室外溫度較高時，室外機的風扇可能會開始轉動，以保護系統。

室內沒有降溫 / 升溫

情況	描述 / 檢查事項
空氣不流出來。	<ul style="list-style-type: none"> 在暖氣運轉中 <ul style="list-style-type: none"> 空調正在預熱。等待約 1 到 4 分鐘。 在除霜運轉過程中，熱空氣不從室內機中排出。 斷路器一被接通，空調器立即運轉 <ul style="list-style-type: none"> 空調正準備運轉。等待約 3 到 20 分鐘。
空氣不流出來 / 空氣流出來。	<ul style="list-style-type: none"> 氣流速率設置是否恰當？ <ul style="list-style-type: none"> 氣流速率設定為「低」嗎，例如設定為「室內機靜音」或「風量 1」？提高氣流速率設定。 設定溫度是否合適？ 風向調整是否合適？
氣流出來。	<ul style="list-style-type: none"> 是否有任何家具擺放在室內機正下方或旁邊？ 空調機是否正處於節能運轉或室外機靜音運轉之下？ 空氣過濾網骯髒嗎？ 室內機或室外機的回風口或出風口是否有異物堵塞？ 有窗戶或門被打開嗎？ 排氣風扇在旋轉嗎？

▶ 第 17, 18 頁

霧氣冒出來

情況	描述 / 檢查事項
室內機中冒出霧氣。	<input checked="" type="checkbox"/> • 在冷氣或其他運轉中，室內空氣被冷卻形成霧氣，就會發生這種現象。

遙控器

情況	描述 / 檢查事項
機器不接收遙控器的信號或其運轉範圍有限	<input checked="" type="checkbox"/> • 電池可能已耗盡。 請將兩顆電池都更換為新的 AAA.LR03 號電池（鹼性）。 有關細節，請參閱「運轉前準備」。▶第 8 頁 • 如果室內有電子啟動器型的螢光燈（如逆變器型燈），訊號通訊可能會失效。 如果發生這種情況，請諮詢您的經銷商。 • 如果發射器暴露在直射陽光下，遙控器可能無法正常工作。
LCD 燈光微弱、不運作，或顯示字幕飄忽不定。	<input checked="" type="checkbox"/> • 電池可能已耗盡。 請將兩顆電池都更換為新的 AAA.LR03 號電池（鹼性）。 有關細節，請參閱「運轉前準備」。▶第 8 頁
LCD 顯示幕閃爍，遙控器無法操作。	<input checked="" type="checkbox"/> • 電池電力耗盡。 同時將兩顆電池更換為全新四號 AAA.LR03（鹼性）電池。 若將電力耗盡的電池留在遙控器內，電池可能漏液、破裂或發熱， 導致人員受傷或設備故障。 （即使 LCD 閃爍，「關」按鈕仍然可以操作。）
其他電子設備開始運作。	<input checked="" type="checkbox"/> • 如果遙控器啟動了其他電子設備，請將它們移開或諮詢您的經銷商。

空氣有異味

情況	描述 / 檢查事項
空調機發出異味。	<input checked="" type="checkbox"/> • 空調機所吸收的室內氣味被排放出來。 我們建議您清潔室內機。請諮詢您的經銷商。

其他

情況	描述 / 檢查事項
在運轉過程中，空調機突然開始出現奇怪的行為。	<input type="checkbox"/> • 空調機可能因雷電或無線電波干擾而發生故障。 如果空調機發生故障，關閉含斷路器的電源，然後使用遙控器重新啟動。

註

關於運轉條件的注意事項

- 除上列情況外，若在任何異常情況下繼續運轉：
 - 安全裝置會啟動以停止運轉。
 - 選擇冷氣或除濕運轉時，室內機表面可能結露並滴水。

模式	運轉條件
冷氣 / 除濕	室外溫度：10~46°C 室內溫度：18~32°C 室內濕度：最高 80%
暖氣	室外溫度：-15~24°C 室內溫度：10~30°C

故障排除

- 立即致電服務提供商。

警告

當出現異常（如燒焦氣味）時，請停止運轉，並關閉斷路器。

- 在出現異常時繼續運轉會導致故障、觸電或火災。
- 請向您購買空調的服務提供商洽詢。

請勿嘗試擅自修理或修改空調。

- 不正確的操作會導致觸電或火災。
- 請向您購買空調的服務提供商洽詢。

如果出現以下任一癥狀，請立即致電服務提供商。

- 電源線異常過熱或受損。
- 運轉中聽見異常聲音。
- 安全斷路器、熔斷器或漏電斷路器頻繁切斷空調機運轉。
- 開關或按鈕經常不能正常工作。
- 出現燒焦氣味。
- 室內機中有水漏出。

請關閉斷路器並致電服務提供商。



■ 停電後

- 空調會在約 3 分鐘內恢復運轉。您只需要等待一小會。

■ 閃電

- 如果有閃電可能打擊附近區域的風險，請停止空調機運轉，並關閉斷路器，以保護系統。

■ 處置要求

- 拆解空調機，處理冷媒、油以及可能的其他部份，均應按照相關的當地與國家規定進行。

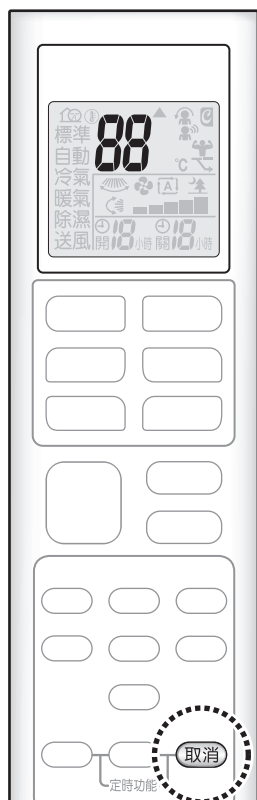

■ 遙控器故障診斷

- 若空調機故障，可先用遙控器查看錯誤代碼，然後再連絡維修人員並告知故障代碼。

1. 按下 **取消** 5 秒鐘後，會有一個「**00**」標示在溫度顯示部份閃爍。

2. 重複按 **取消**，直到您聽到長音「嗶」。

- 代碼標示即按照下表發生改變，並以長音「嗶」提醒用戶。

	代碼	含義
系統	00	正常
	UA	室內機、室外機組合故障
	U0	冷媒不足
	U2	電壓下降或主電路過電壓
	U4	訊號傳輸故障（室內機與室外機之間）
室內機	A1	室內機印刷電路板 (PCB) 故障
	A5	高壓控制或防凍結保護裝置
	A6	風扇電機故障
	C4	熱交換器溫度感應器故障
	C9	吸入空氣溫度感應器故障
室外機	EA	冷氣 - 暖氣切換故障
	E1	電路板故障
	E5	過載保護啟動
	E6	壓縮機啟動故障過載保護啟動
	E7	風扇直流電機故障
	E8	過電流輸入
	F3	排水管高溫控制
	F6	高壓控制（冷氣模式下）
	F8	因壓縮機內部溫度異常而停止運轉
	H0	感應器故障
	H6	位置探測感應器故障導致的運轉停止
	H8	直流感應器故障
	H9	吸入空氣溫度感應器故障
	J3	排水管溫度感應器故障
	J6	熱交換器溫度感應器故障
	L3	電氣部件過熱故障
L4	變頻器電路散熱器高溫	
L5	輸出電流過載	
P4	變頻器電路散熱器感應器故障	

註

- 一聲短音「嗶」與 2 聲長音「嗶」表示無相應的代碼。
- 如需取消代碼顯示，按住 **取消** 5 秒鐘即可。如果 1 分鐘內未按下按鈕，代碼顯示也會自動取消。

產品規格

室內機	型號		FTXV22UVLT	FTXV28UVLT	FTXV36UVLT
尺寸	H mm		285		
	W mm		770		
	D mm		226		
重量	kg	9			
冷氣運轉時運轉音量	dB(A)		42		44
熱泵暖氣運轉時運轉音量	dB(A)		40		42
室外機	型號		RXV22UVLT	RXV28UVLT	RXV36UVLT
室內機組合例			FTXV22UVLT	FTXV28UVLT	FTXV36UVLT
冷氣運轉時 (CNS)	能力	W	2200	2800	3500
	能力	kcal/h	1890	2410	3010
	運轉電流	A	2.3	3.1	3.8
	消耗電功率	W	455	620	785
	COP	W/W	4.84	4.52	4.46
	CSPF	kWh/kWh	6.66	6.12	6.52
熱泵暖氣運轉時 (CNS)	能力	W	2700	3400	3800
	能力	kcal/h	2320	2920	3270
	運轉電流	A	2.9	3.7	5.0
	消耗電功率	W	590	765	1030
組合電源			1φ220V60Hz 電源連接 (室外機)		
尺寸	H mm		550		595
	W mm		675		845
	D mm		284		300
重量	kg		28		38
注意：	<ul style="list-style-type: none"> 能力及電流特點是依下述條件： 冷氣運轉時...27°C DB, 19°C WB 室內溫度及 35°C DB 室外溫度，高風速· 220V· 60Hz 熱泵暖氣運轉時...20°C DB, 15°C WB 室內溫度及 7°C DB, 6°C WB 室外溫度，高風速· 220V· 60Hz 根據中華民國標準 (CNS) 本規格表刊載的機型和規格會因產品更新而變化，恕不另行通知。 上述以外的規格請參閱產品型錄。 				
室內機	型號		FTXV22UVLT	FTXV28UVLT	FTXV36UVLT
室外機	型號		RXV22UVLT	RXV28UVLT	RXV36UVLT
生產國	室內機：泰國製造 室外機：泰國製造				
進口商名稱	和泰興業股份有限公司 台北市內湖區新湖一路 36 巷 18 號 電話 0800-060-580				

快速參考

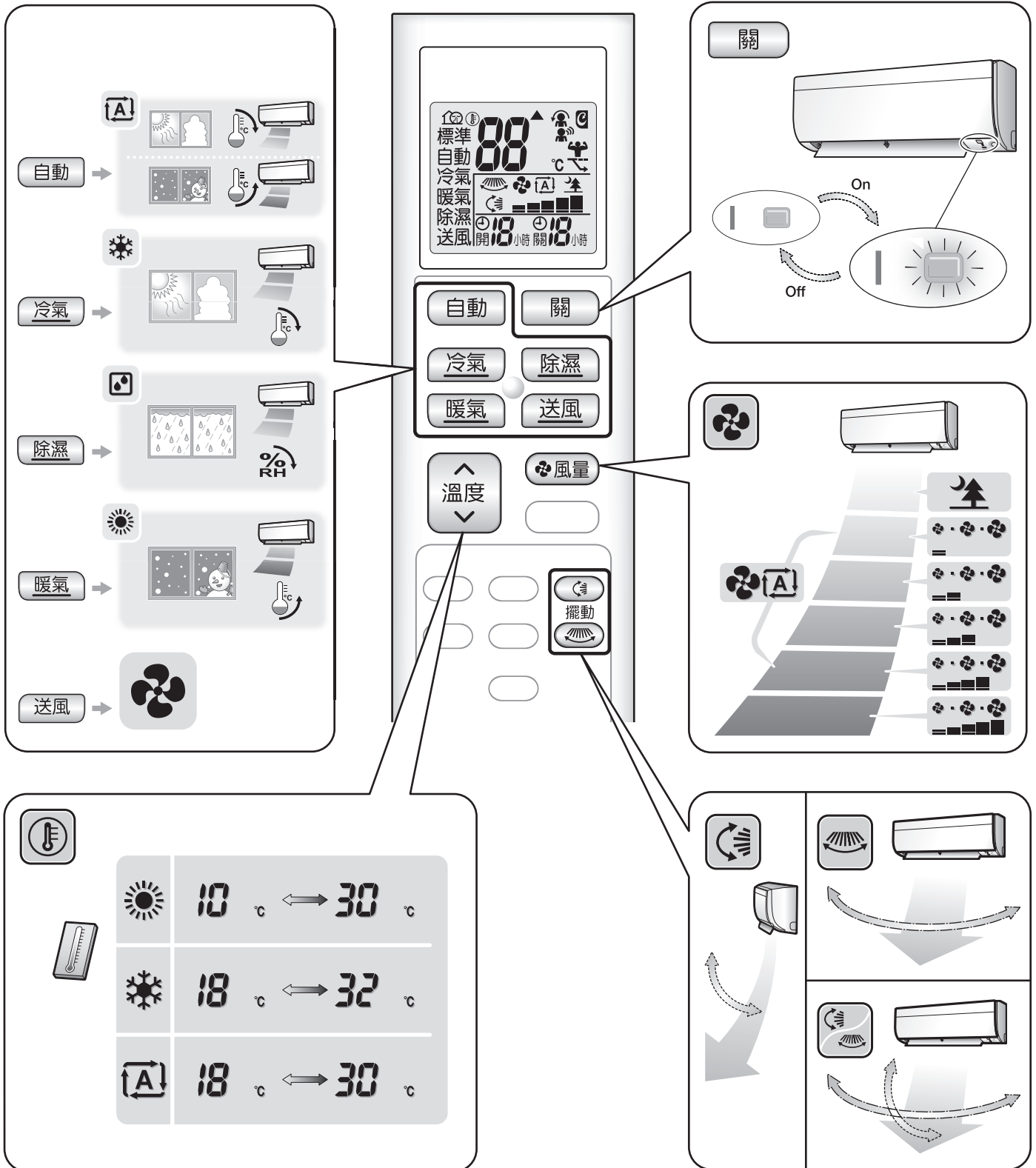

DAIKIN INDUSTRIES, LTD.

Head office:
Umeda Center Bldg., 2-4-12, Nakazaki-Nishi,
Kita-ku, Osaka, 530-8323 Japan

Tokyo office:
JR Shinagawa East Bldg., 2-18-1, Konan,
Minato-ku, Tokyo, 108-0075 Japan
<https://www.daikin.com>

大金工業株式会社

總公司
日本大阪府大阪市北區中崎西二丁目4番12號
梅田中心大廈 郵遞區號 530-8323

東京分公司
日本東京都港區港南二丁目18番1號
JR品川東大廈 郵遞區號108-0075



The two-dimensional bar code is a manufacturing code.

3P492259-17L M19N095 (1912)HT