

▶ 第 8 節 (續)

所需的工具和五金件

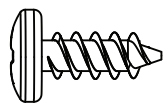

ADZ (x6)

8.2

- 將擱板 (AFV) 末端的翻蓋折疊起來，然後將擱板放在支架上。沿長邊的缺口應緊靠後壁。

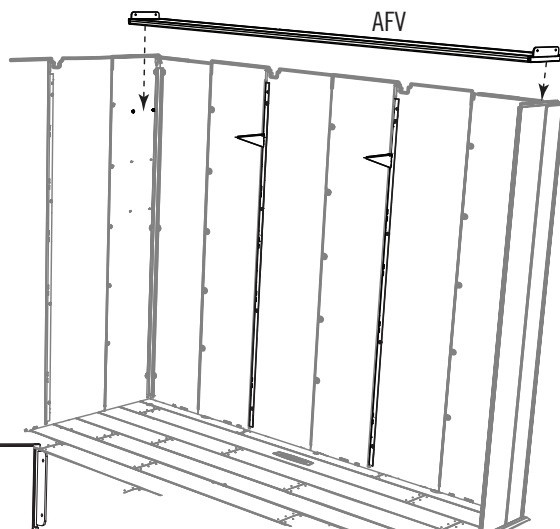
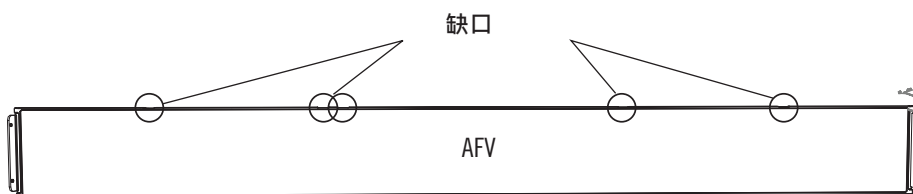

8.3

- 使用六 (6) 顆螺釘 (ADZ) 將擱板 (AFV) 連接到角壁板和擱板支架上。

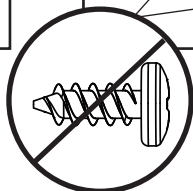
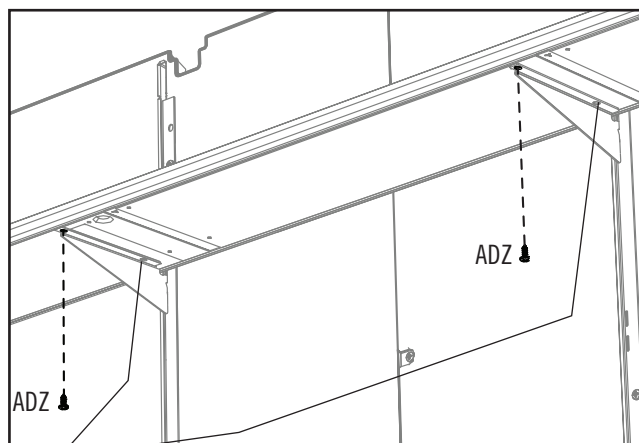
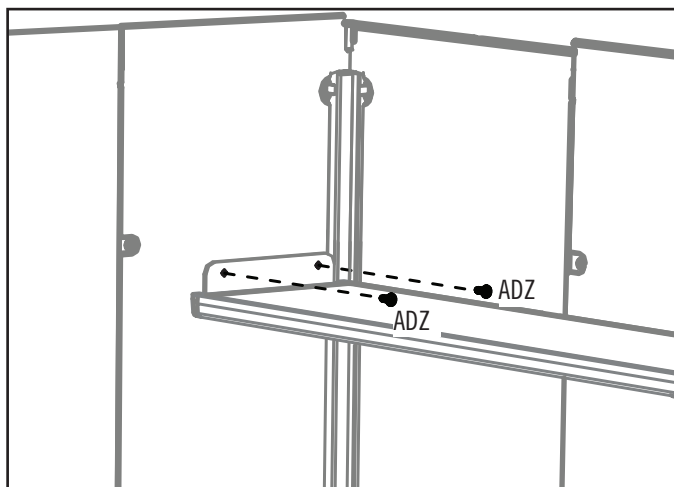

↓ **50 lb. (23 kg)**

9

門和入口山牆安裝



所需的五金件

五金袋

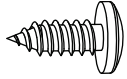

ADX (x4)



AHP (x2)

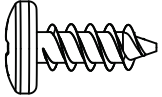

ADZ (x6)

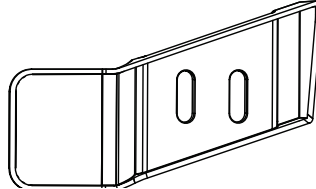

AIM (x1)

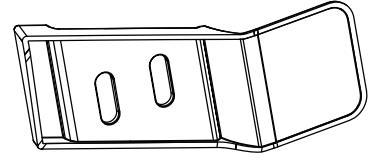

AIC (x1)



所需的零件

塑膠件

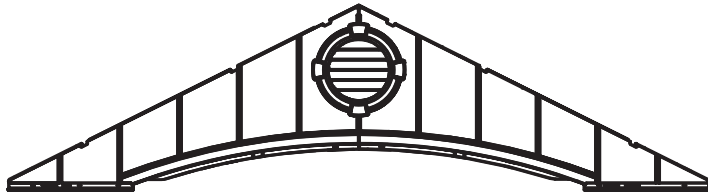

(x1)

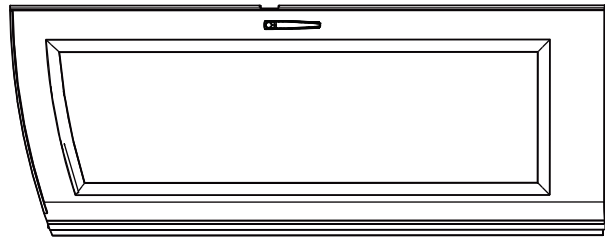

(x1)

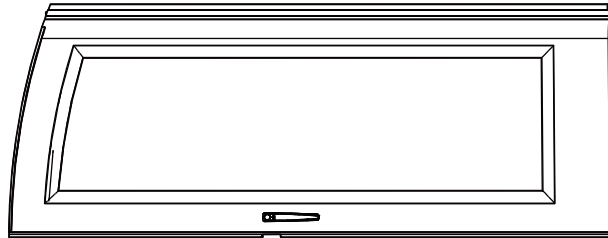

(x1)



所需工具 (不包括在內 — 除非另有說明)

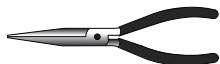

▶ 第 9 節 (續)

所需的工具和五金件



AHP (x1)

9.1

- 將合頁管拉出門約六英寸。將合頁管底部的孔與襯套中的狹縫對齊，然後插入合頁管。插入開口銷 (AHP) 並彎曲末端。

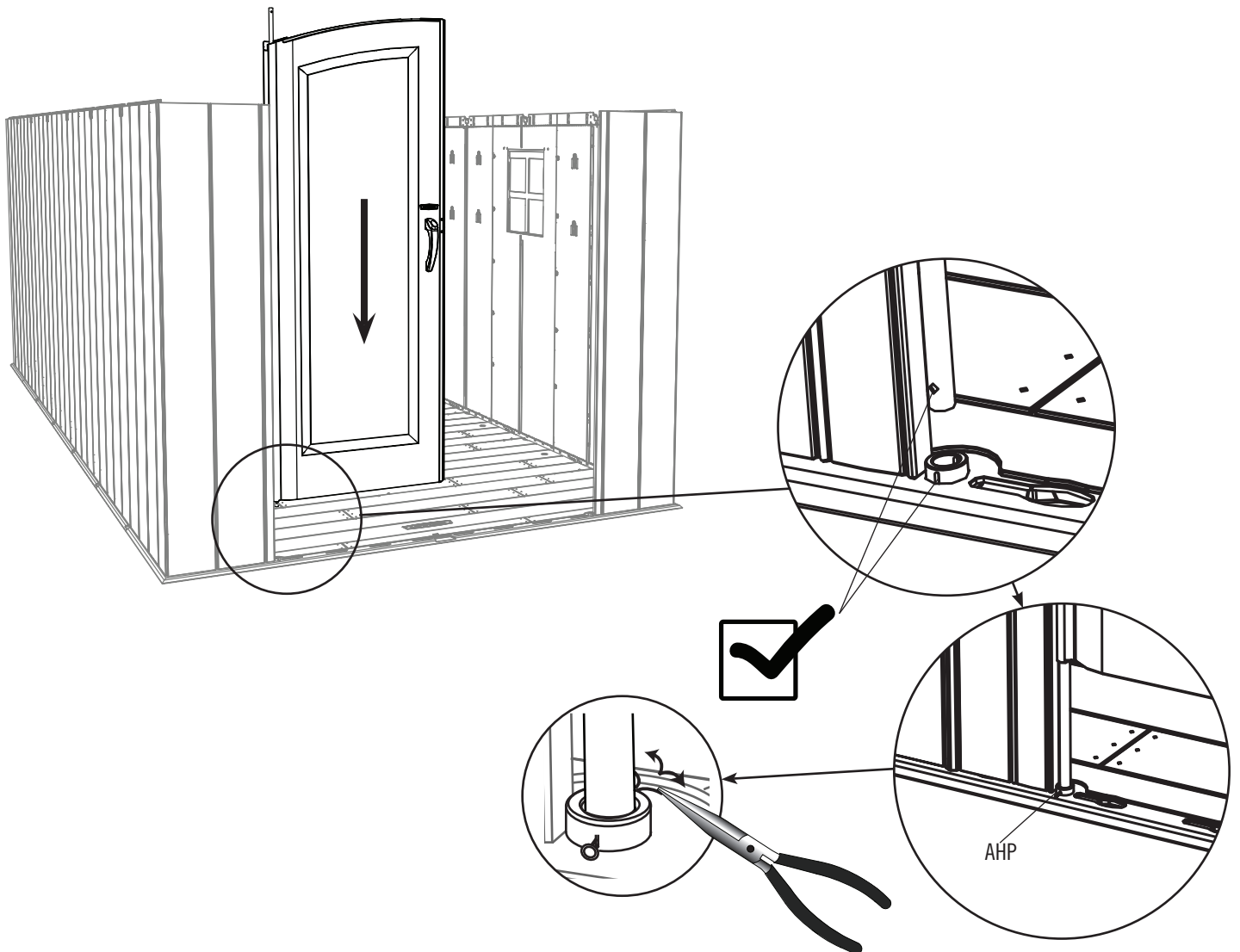

► 第 9 節 (續)

所需的工具和五金件

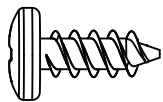
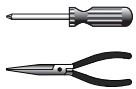

ADZ (x6)



AHP (x1)

9.2

- 對右門重複執行上一步。

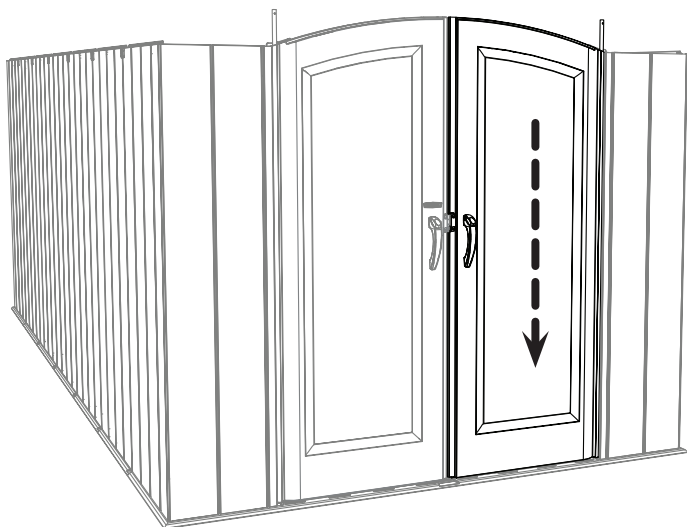

9.3

- 將入口山牆上的孔向下滑動到兩根合頁管上。

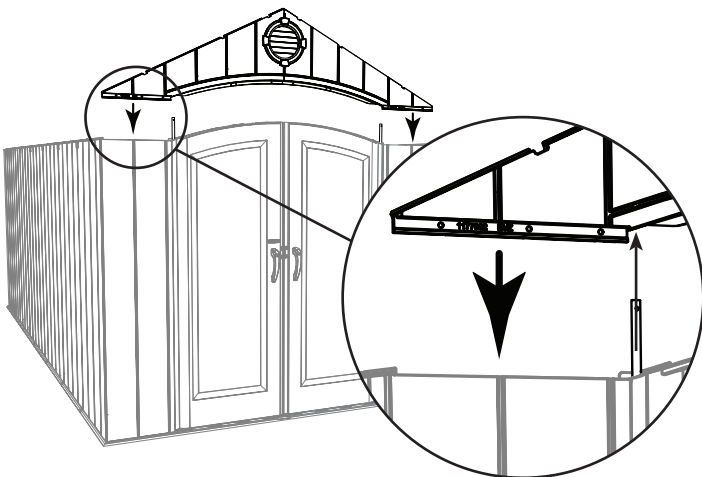

9.4

- 使用六 (6) 顆螺釘 (ADZ) 將入口山牆固定到儲物棚上。

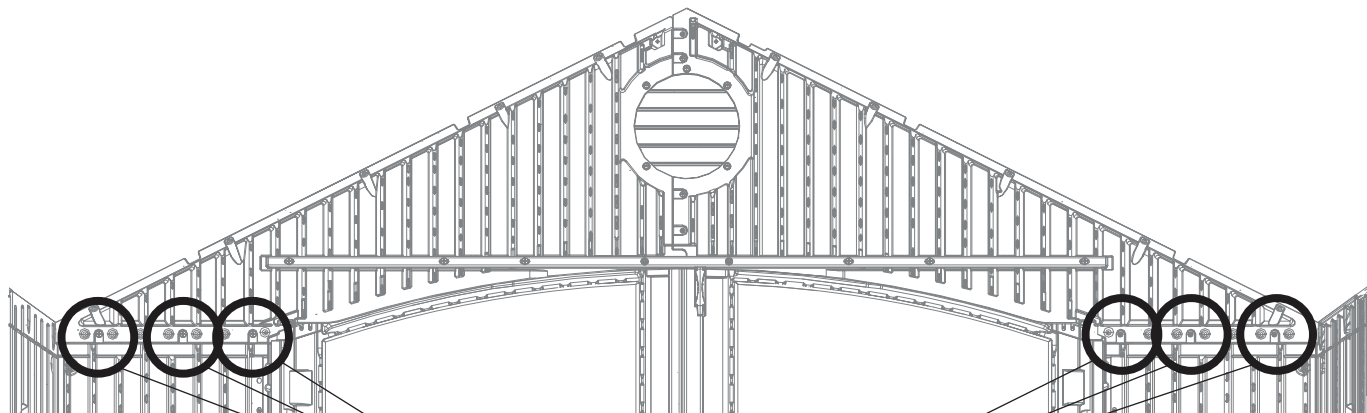

ADZ

ADZ

► 第 9 節 (續)

所需的工具和五金件

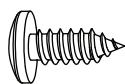

ADX (x4)

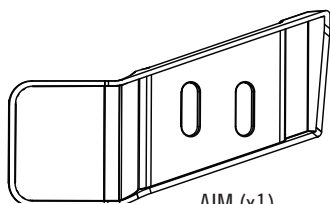

AIM (x1)

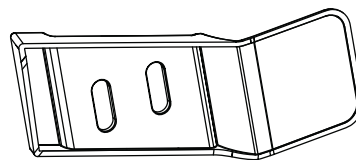

AIC (x1)

9.5

- 使用隨附的五金件將左 (AIC) 和右 (AIM) 間隙翻蓋連接到門的角部。這些翻蓋只是用來阻擋光線。

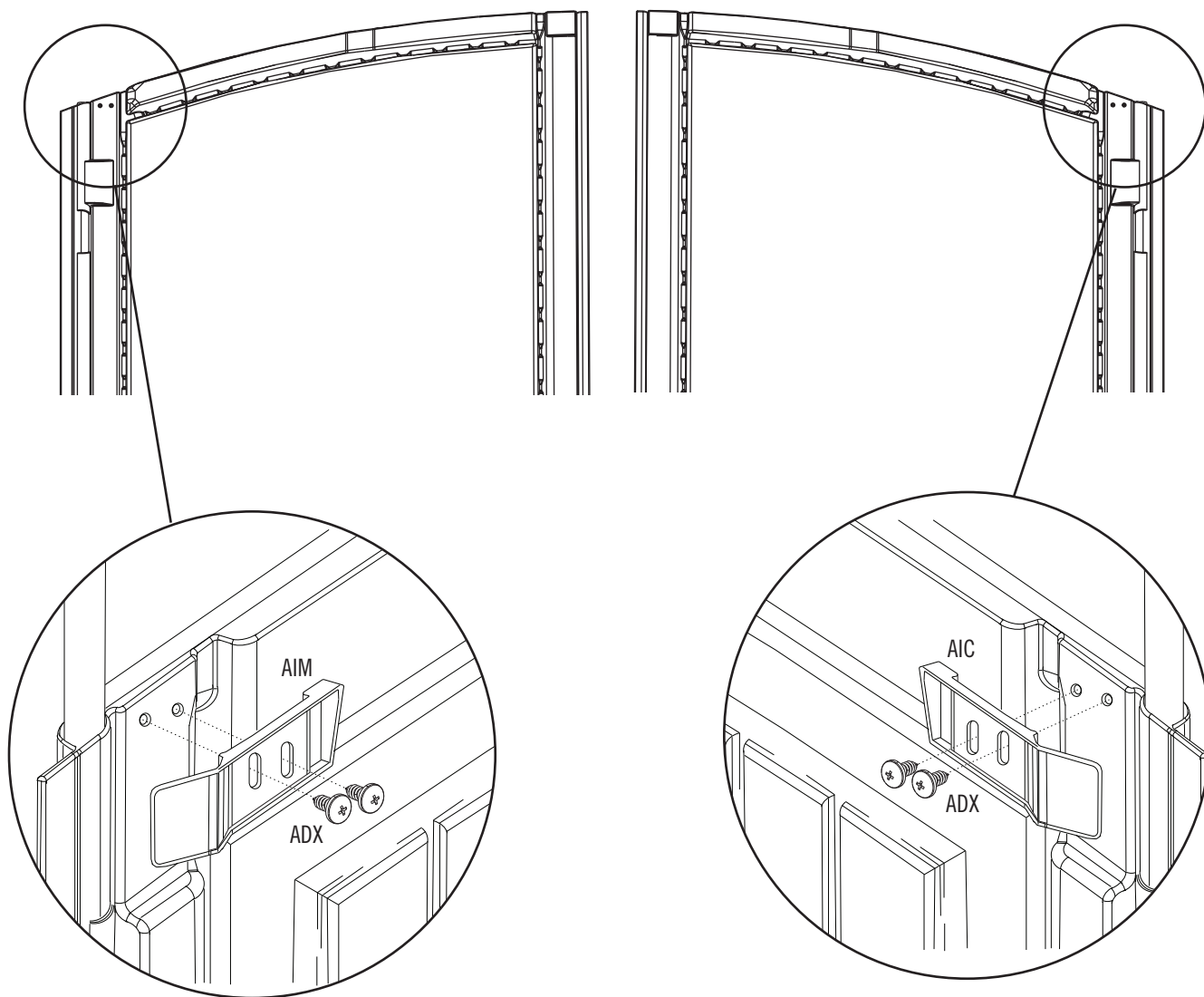

10

棚頂組裝



所需的五金件

五金袋

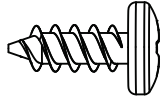

ADZ (x204)

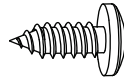

ADX (x42)

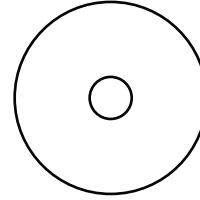

AED (x42)



所需的零件

金屬件



AFL (x14)

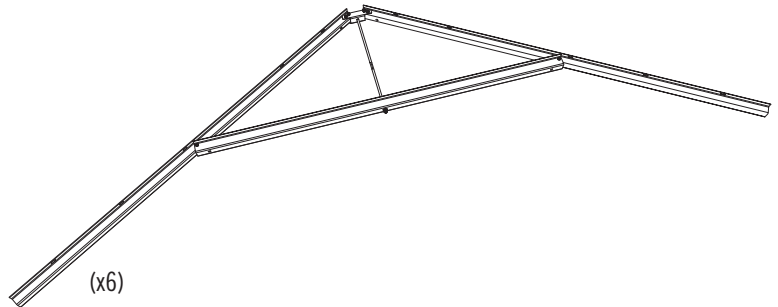

(x6)

塑膠件

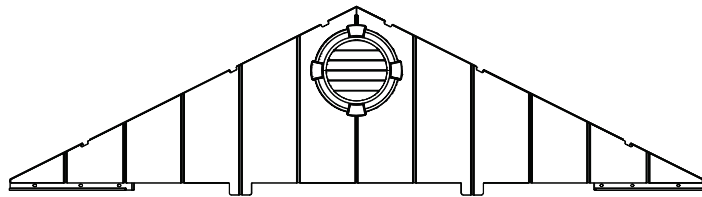

(x1)

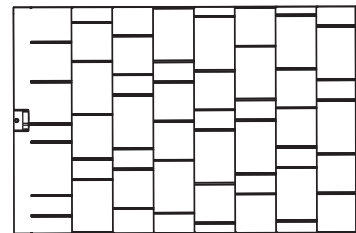

AGQ (x14)

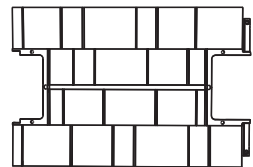

AFY (117) (x6)

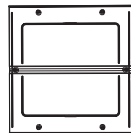

AHC (x7)

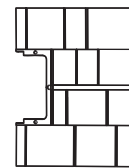

AFW (116) (x1)

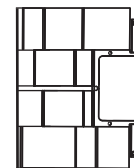

AGG (115) (x1)



所需工具 (不包括在內 — 除非另有說明)

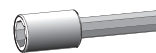
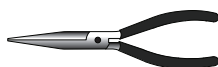

3/8" (≈10 mm)

▶ 第 10 節 (續)

所需的工具和五金件



10.1

- 將桁架組件放置到前兩個相對壁板上的槽口中。將**棚頂板 (AGQ)** 放置到山牆、壁板和桁架組件上。

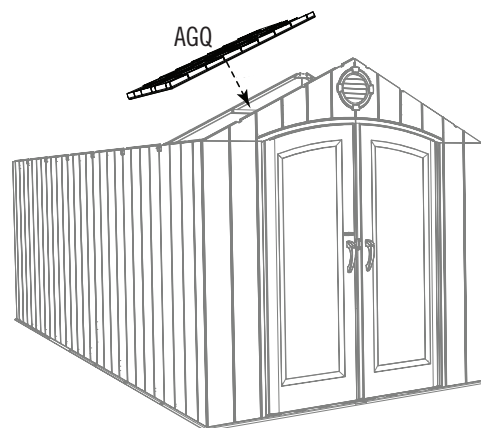
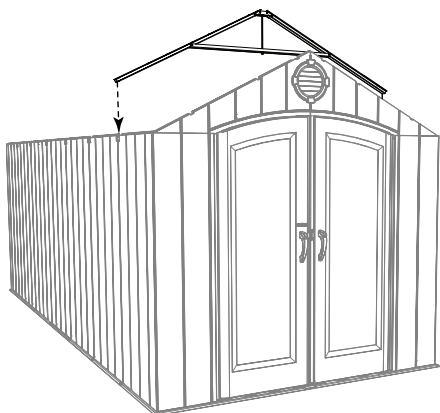

10.2

- 將棚頂板底部的凹槽放置在壁板的頂部。確保對齊小塊適合桁架的槽口。

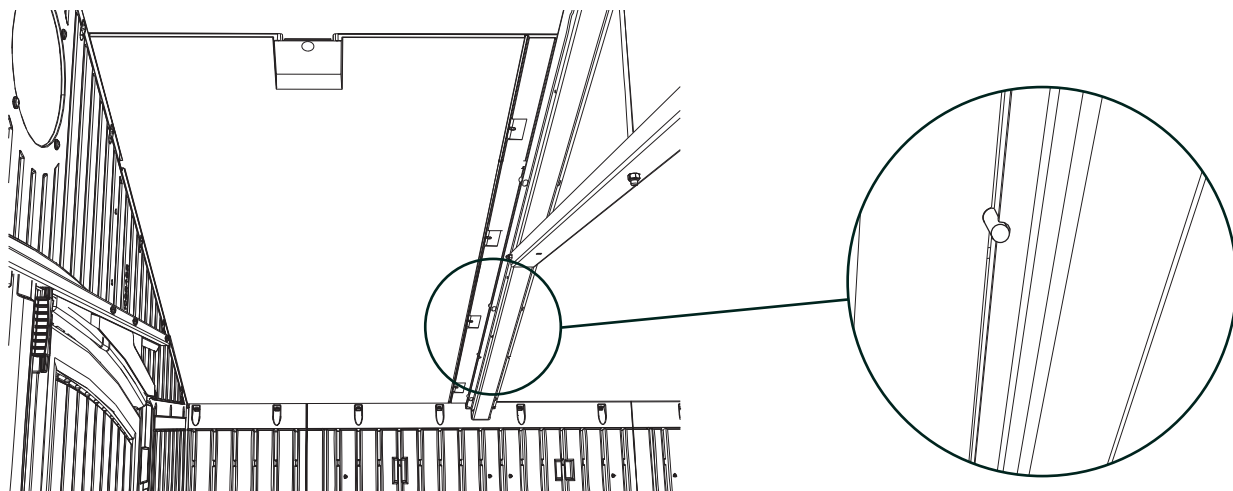

▶ 第 10 節 (續)

所需的工具和五金件

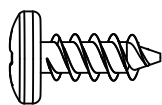

ADZ (x4)

10.3

- 將壁板上的四個孔與棚頂板底部的孔對齊，然後插入四 (4) 顆螺釘 (ADZ) 以將板固定到位。

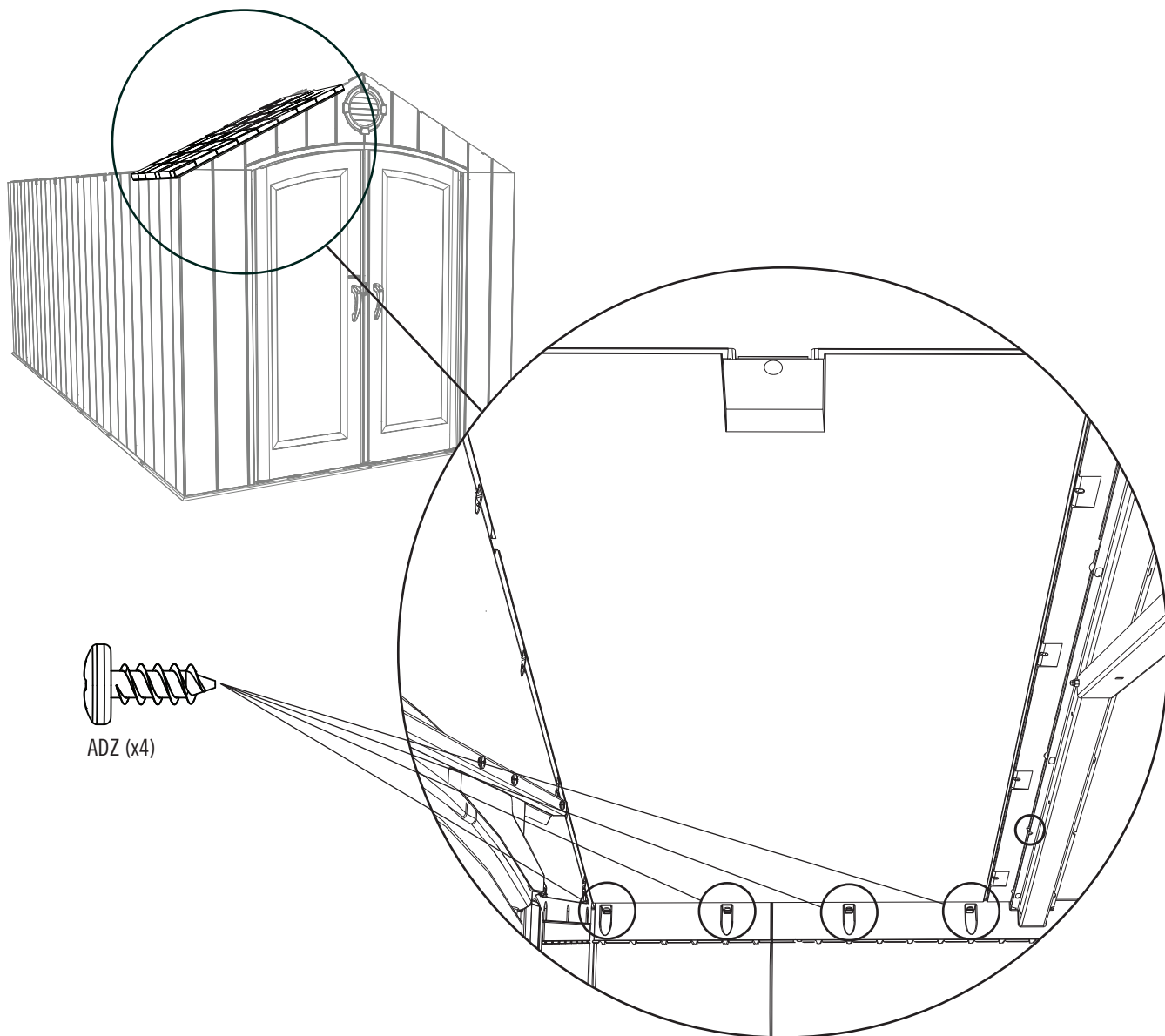

▶ 第 10 節 (續)

所需的工具和五金件

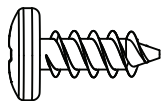

ADZ (x4)

10.4

- 將前兩顆螺釘 (ADZ) 穿過山牆並插入棚頂板。將前兩顆螺釘 (ADZ) 插入所示位置的桁架和棚頂板。

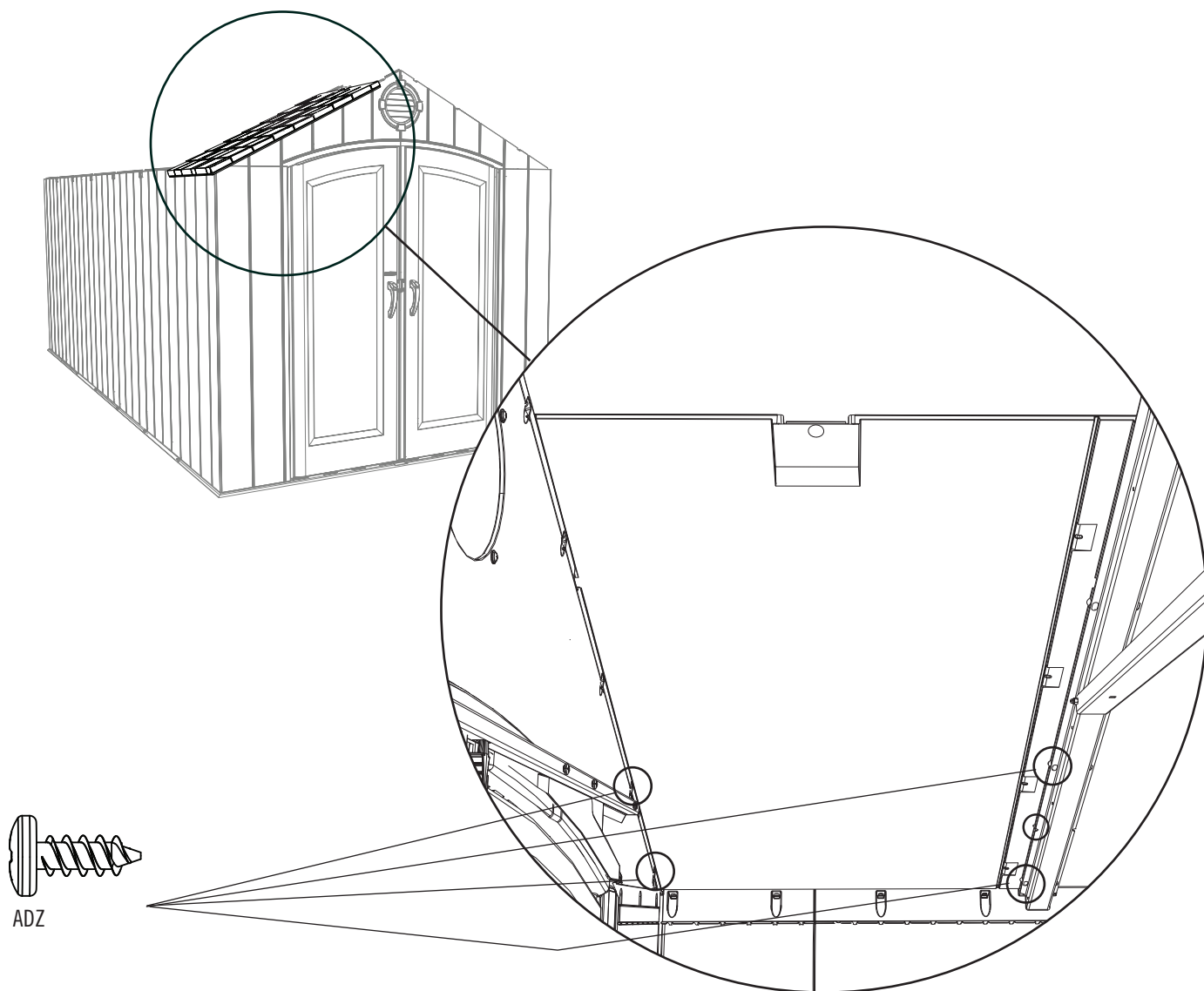

▶ 第 10 節 (續)

所需的工具和五金件

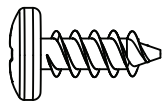

ADZ (x14)

10.5

- 將棚頂支架 (AFL) 插入山牆的槽口以及桁架和棚頂板之間。再插入三 (3) 顆螺釘 (ADZ) 以將板固定到位。

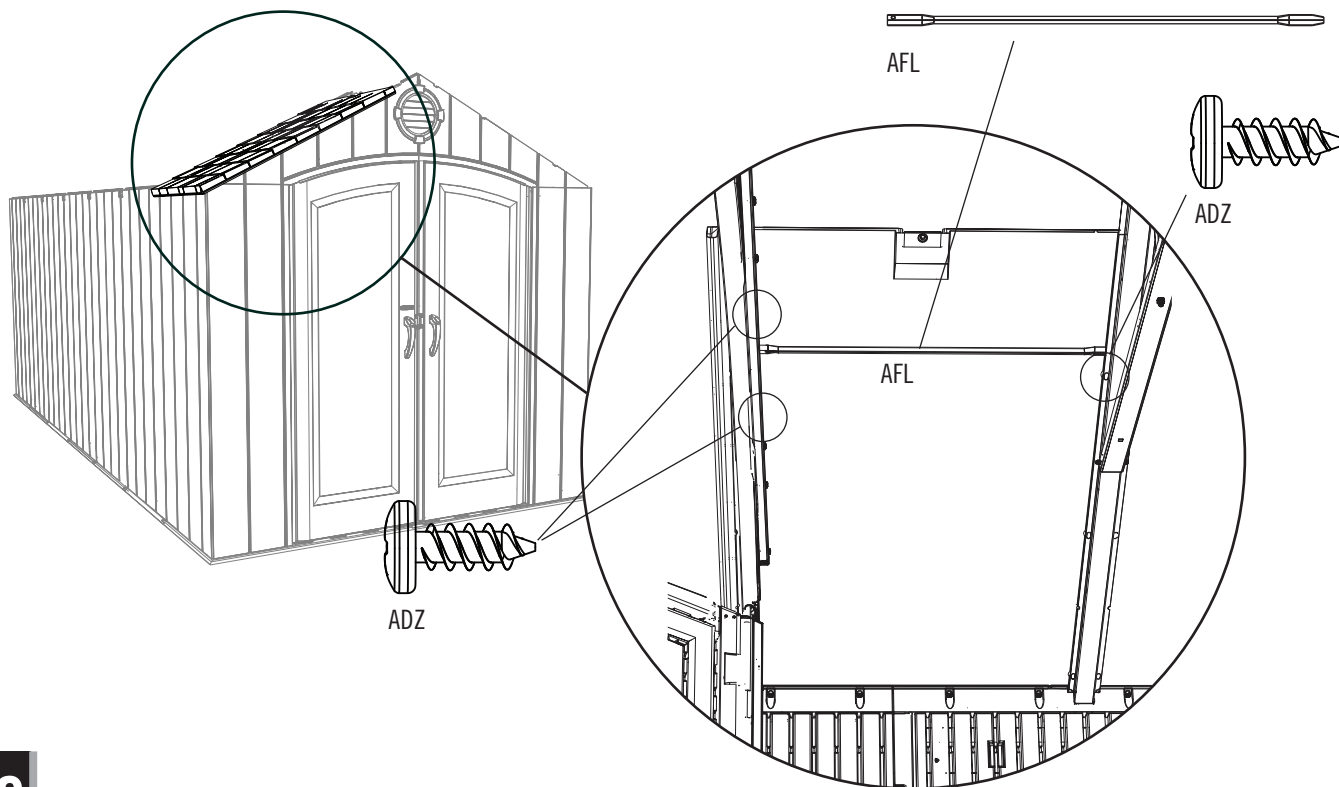

10.6

- 對第二個前棚頂板重複執行步驟 10.2–10.5。

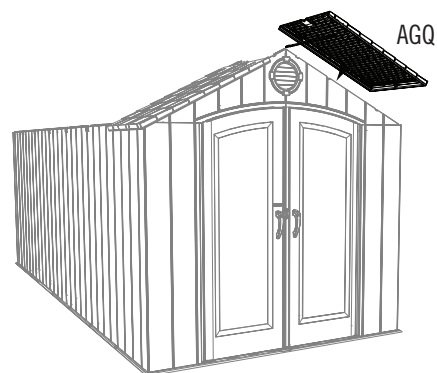

▶ 第 10 節 (續)

所需的工具和五金件

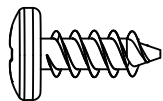

ADZ (x80)

10.7

• 對中央棚頂板重複執行前面的步驟，但每塊都由十 (10) 顆螺釘 (ADZ) 固定。

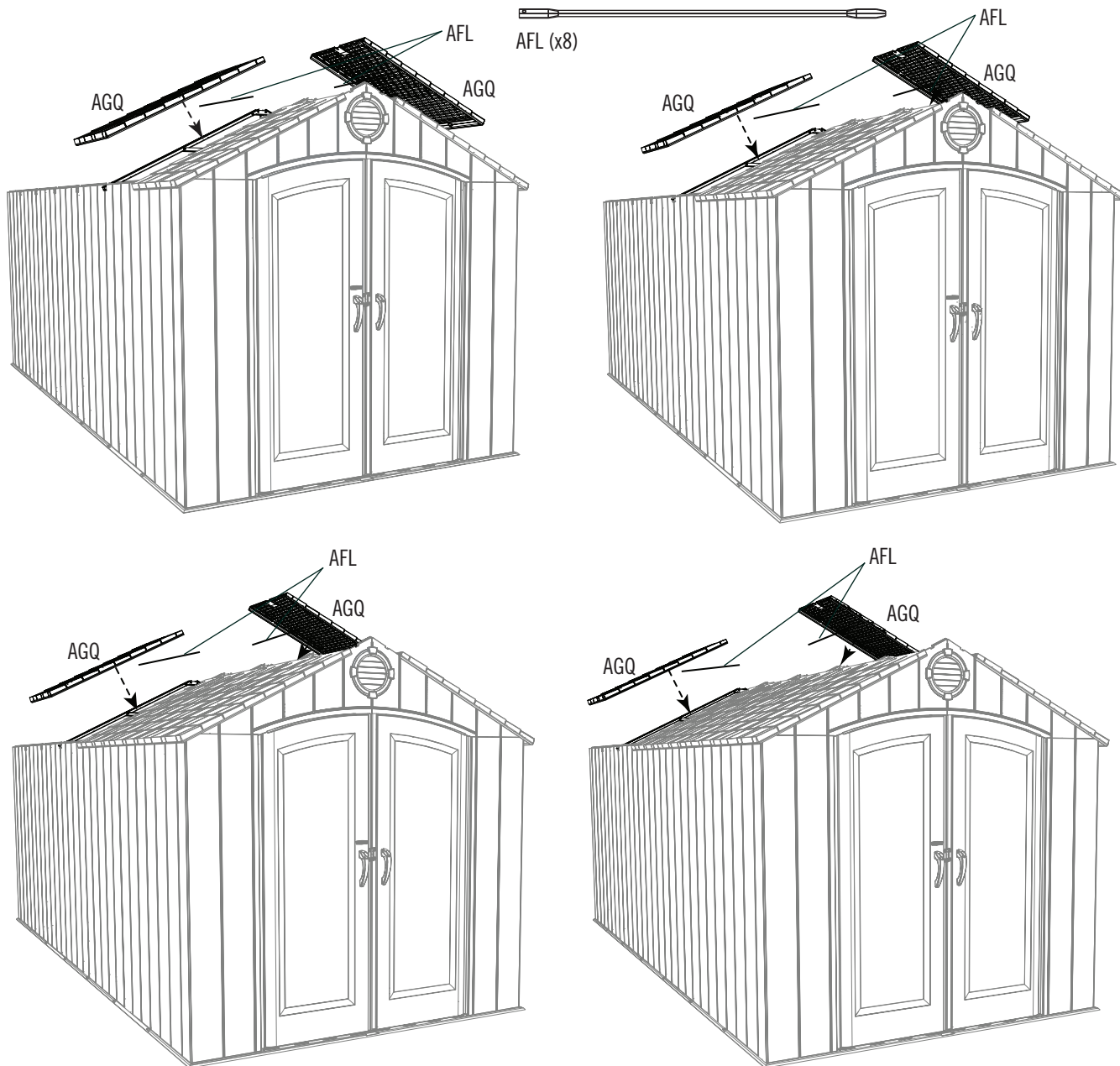

▶ 第 10 節 (續)

所需的工具和五金件

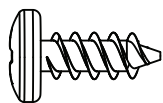

ADZ (x20)

10.8

- 對這些中央棚頂板重複執行前面的步驟。

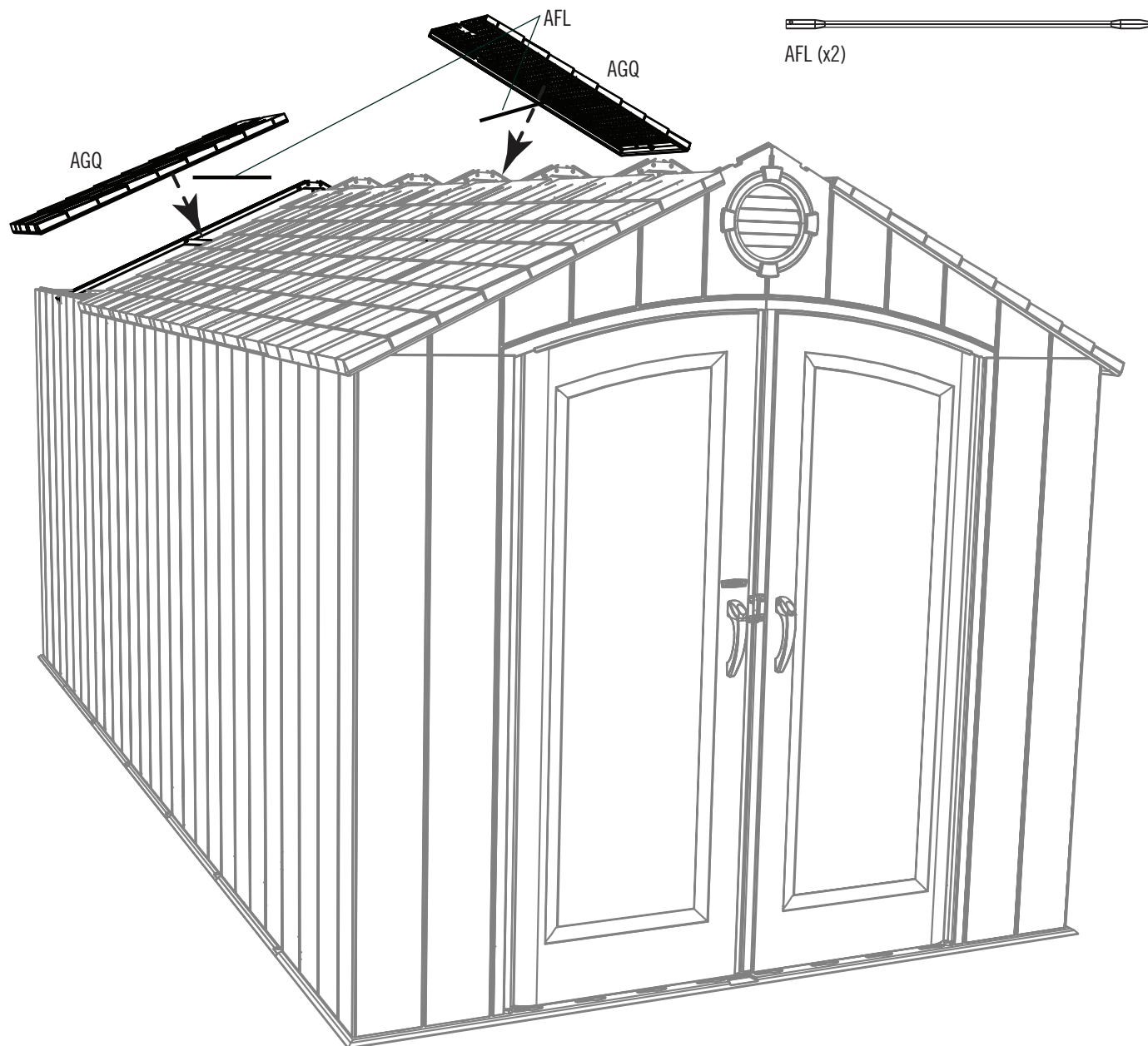

▶ 第 10 節 (續)

所需的工具和五金件

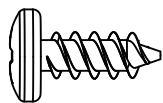

ADZ (x36)

10.9

使用十四 (14) 顆螺釘 (ADZ) 將後山牆連接到儲物棚上。

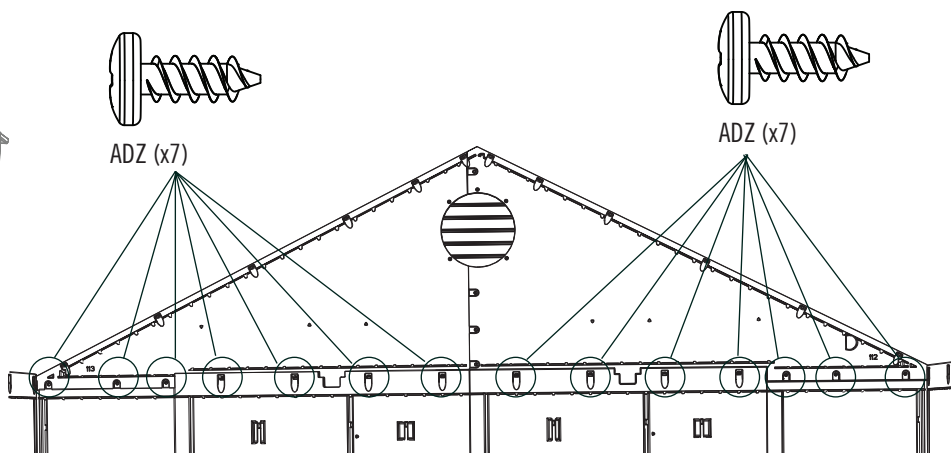
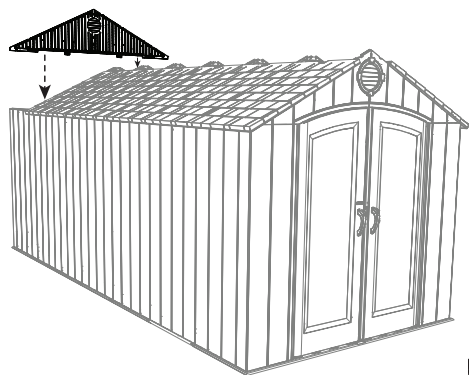

10.10

• 以與前兩塊相同的方式將最後兩塊棚頂板連接到儲物棚上。

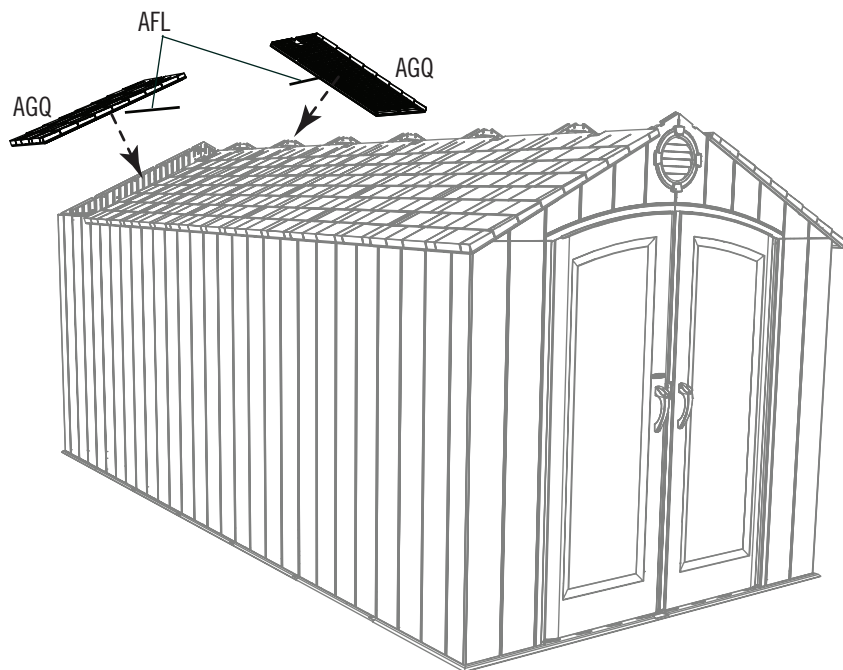

AFL (x2)

▶ 第 10 節 (續)

所需的工具和五金件

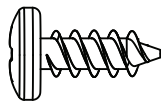

ADZ (x42)

10.11

- 從前面開始，使用隨附的五金件將棚頂蓋連接到儲物棚上。



棚頂蓋的末端彼此搭接。

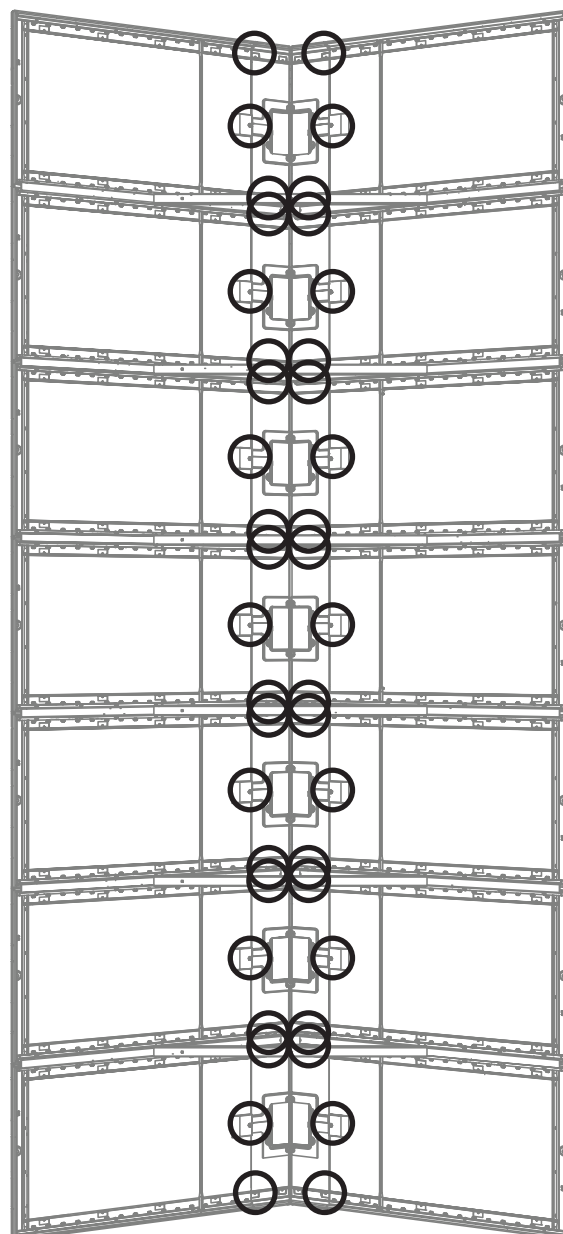
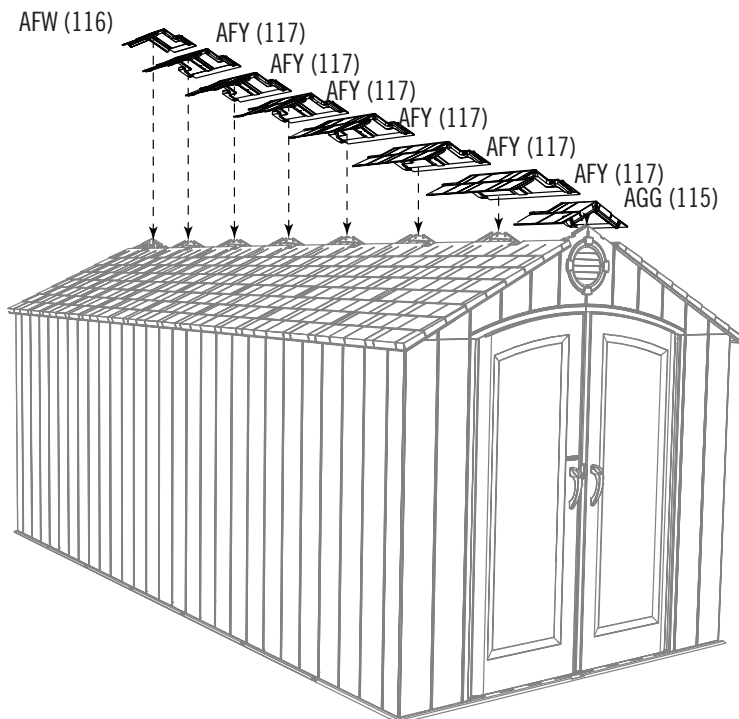

▶ 第 10 節 (續)

所需的工具和五金件

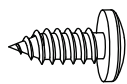

ADX (x42)

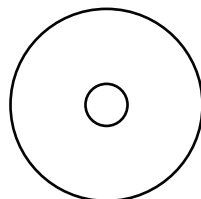

AED (x42)

10.12

- 折疊天窗 (AHC) 並每個天窗使用六 (6) 顆螺釘 (ADX) 和墊圈 (AED) 將其連接到棚頂。



對剩餘的四個天窗重複執行此步驟。

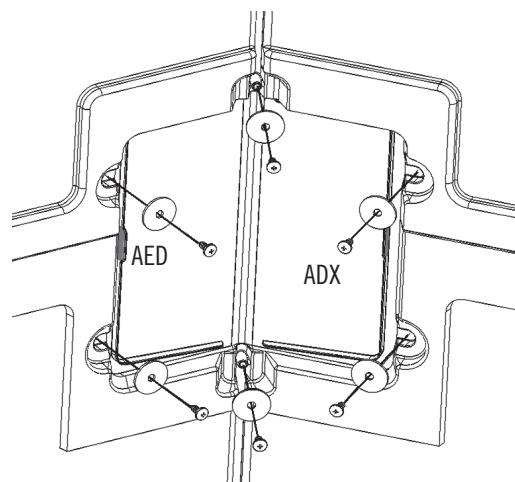
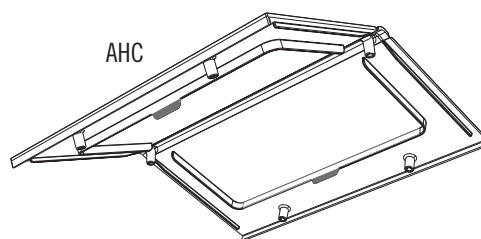
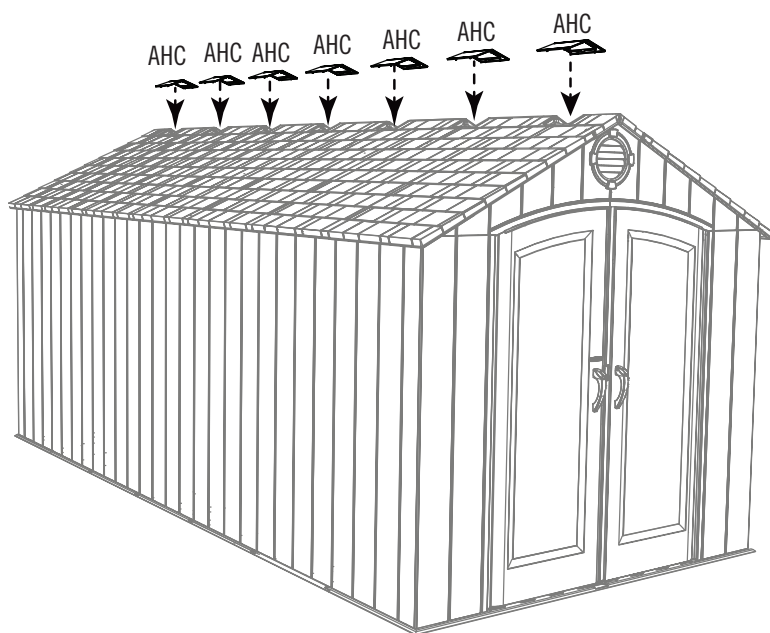

11

窗戶安裝



所需的五金件

五金袋

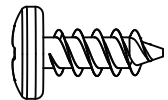
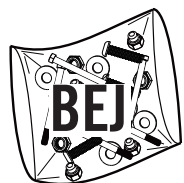

ADZ (x4)

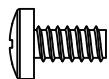

ADY (x1)

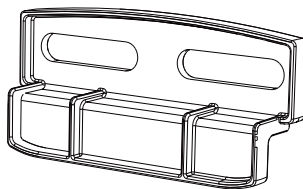

AIS (x2)



所需的零件

塑膠件

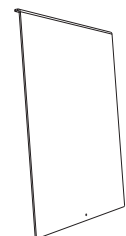

AHE (x1)



所需工具 (不包括在內 — 除非另有說明)



▶ 第 11 節 (續)

所需的工具和五金件

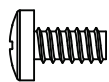

ADY (x1)

11.1

如果您在本章節中遇到問題，請按照下面的代碼觀看本章節中有關組裝的視頻。



<http://go.lifetime.com/8wininstall>

11.2

撕下窗玻璃 (AHE) 兩側上的保護層。

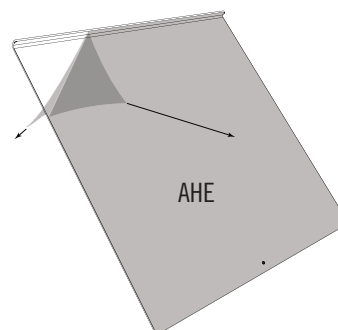

11.3

讓彎曲的邊緣在頂部並面向您，將窗玻璃向下滑動到開口中。

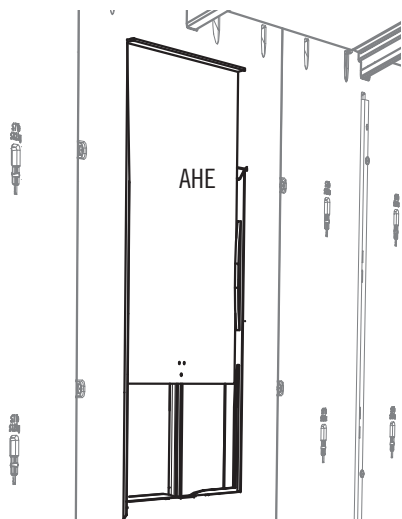

11.4

將螺釘 (ADY) 插入窗底部的孔中。這有助於在窗玻璃打開時保持打開狀態。

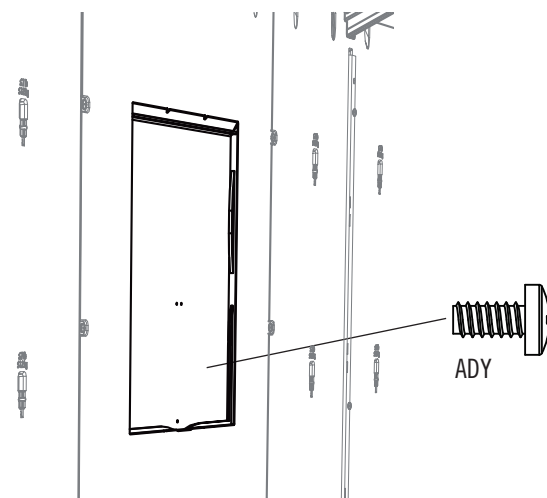

▶ 第 11 節 (續)

所需的工具和五金件

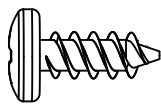

ADZ (x4)

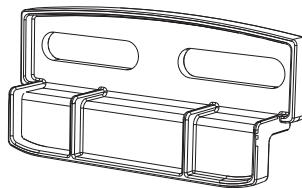

AIS (x2)

11.5

將兩 (2) 把窗門鎖 (ADY) 連接到板開口的頂角上。

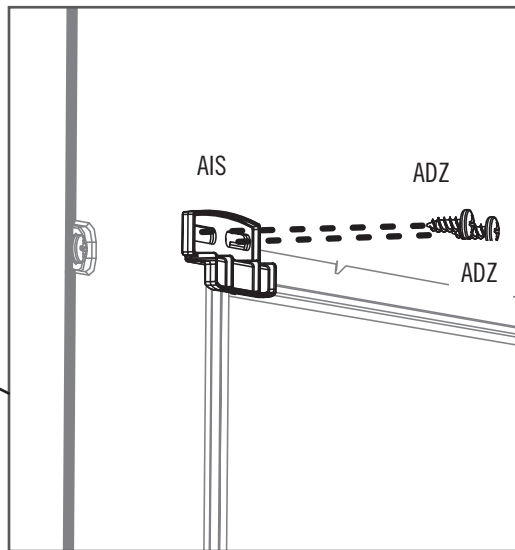
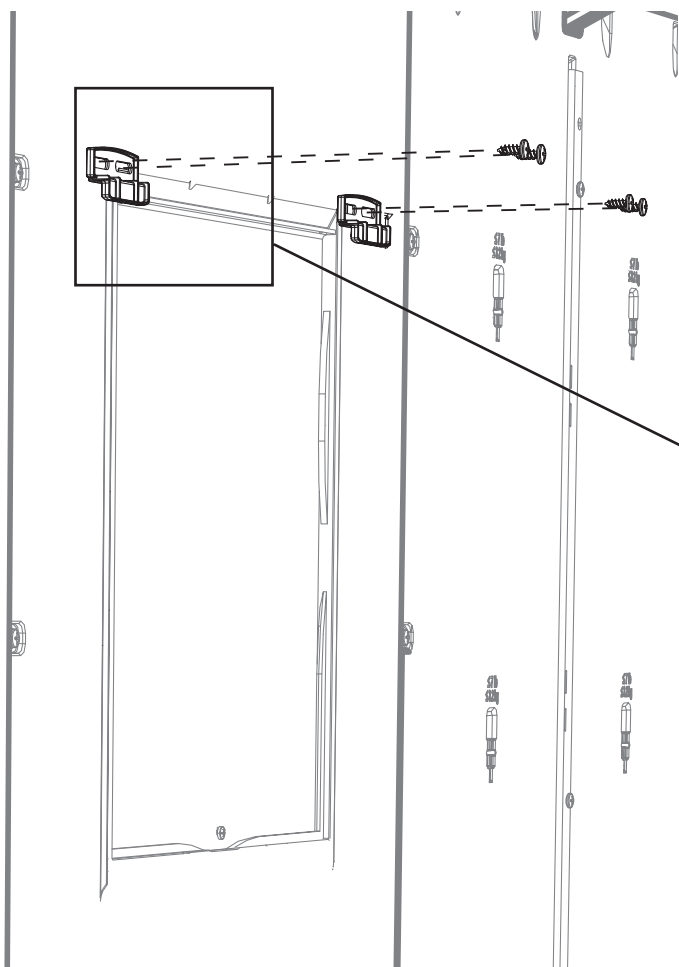

• 門鎖應可移動自如。

12

壁鉤安裝



所需的五金件

壁鉤袋

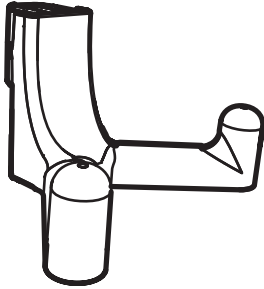

EDL (x6)



所需的零件



所需工具 (不包括在內 — 除非另有說明)



► 第 12 節 (續)

所需的工具和五金件

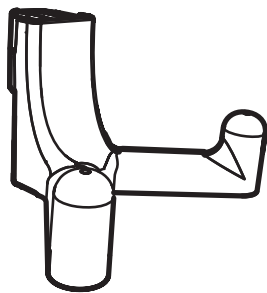

EDL (x6)

12.1

將六 (6) 個壁鉤 (EDL) 插入壁板 (儲物棚的任一側) 的任何槽口中。然後向下推以將它們鎖定到位。



警告

牆鉤總重不得大於7磅 (3.2kg) 或一塊牆嵌板上總重不得超過30磅 (14kg)。超過這一限度或將導致財產損失及/或人身傷害。

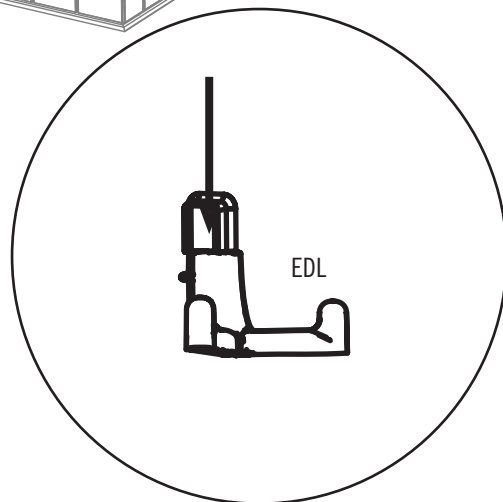
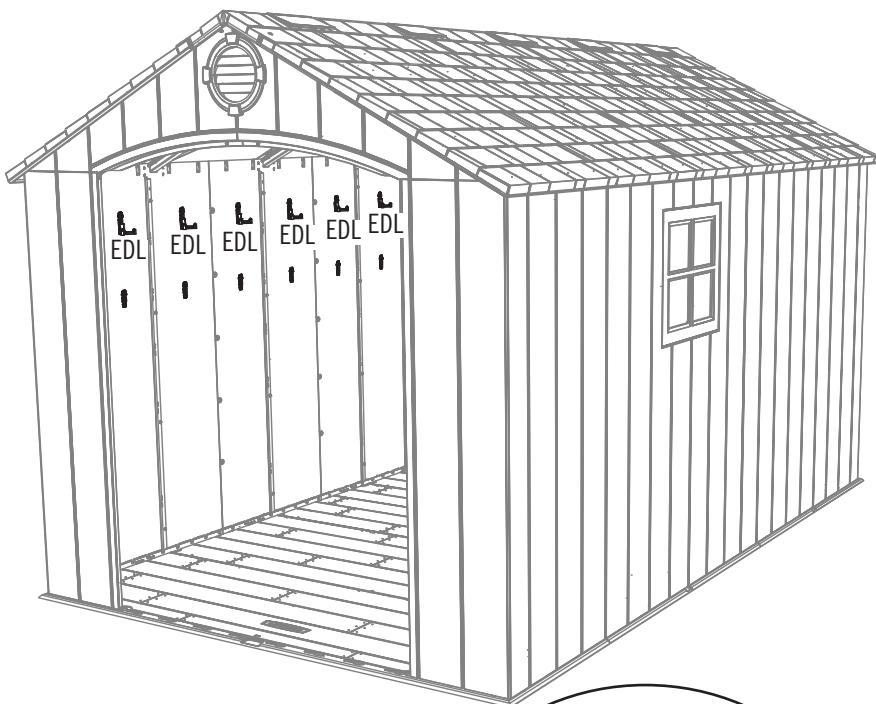

13

門對齊



所需的五金件



所需的零件

塑膠件

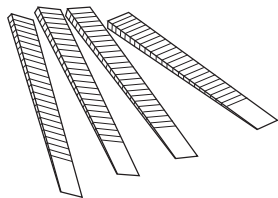

AIX (x4)



所需工具 (不包括在內 — 除非另有說明)

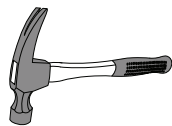

▶ 第 13 節 (續)

所需的工具和五金件

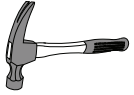

AIX (x4)



如果您在本章節中遇到問題，請按照下面的代碼觀看本章節中有關組裝的視頻。

13.1

如果門在頂部不平，請按照本頁上的步驟將它們對齊。



<http://go.lifetime.com/8alignment>

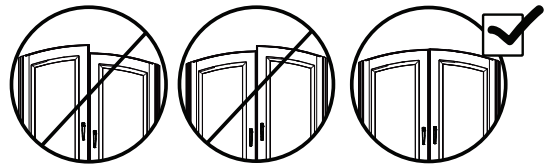

13.2

如果右門刮擦地板或低於左門，請在右門底角和/或儲物棚左後角正下方的地板下插入墊片 (AIX)。如必要，對左門重複執行此步驟，直到兩扇門都水平且不會刮擦為止。切掉任何多餘的墊片。

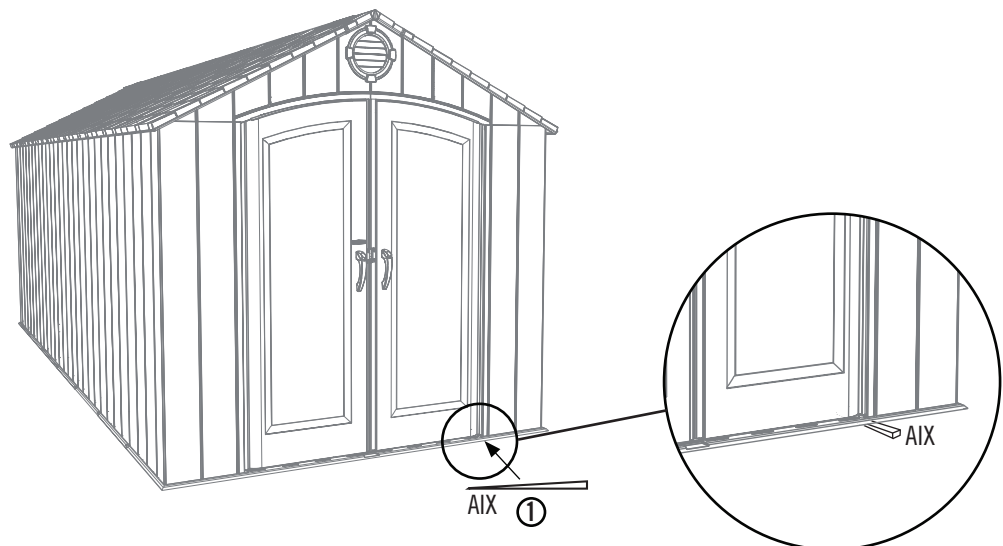

14

儲物棚錨定



所需的五金件



所需的零件



所需工具 (不包括在內 — 除非另有說明)

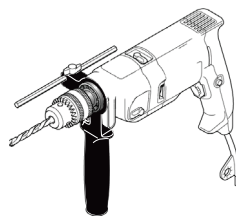
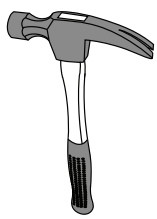

 5/16 英吋 (≈8 毫米) 木鑽頭

 5/16 英吋 (≈8 毫米) 砌體鑽頭

▶ 第 14 節 (續)

對於混凝土平台

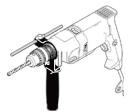

5/16 in/po
(≈8 mm)



14.1



要錨定您的儲物棚，您必須購買正確的錨定五金件。對於**混凝土平台**，我們建議使用鎚鑽、5/16 英寸 (8 釐米) 砌體鑽、十四 (14) 顆 3/8 英寸 x 2 英寸 (10 毫米 x 5 釐米) 混凝土螺釘和十四 (14) 顆 3/8 英寸 x 1 英寸 (10 毫米 x 2.5 釐米) 防塵墊圈。不要使用超過 3/8 英寸直徑的螺釘。有關此五金件，請查詢您當地的五金件商店。

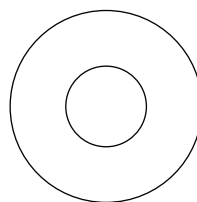
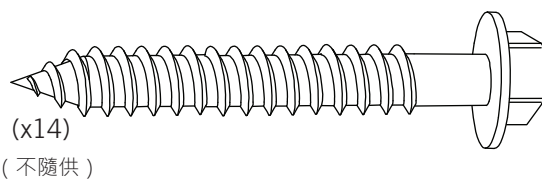
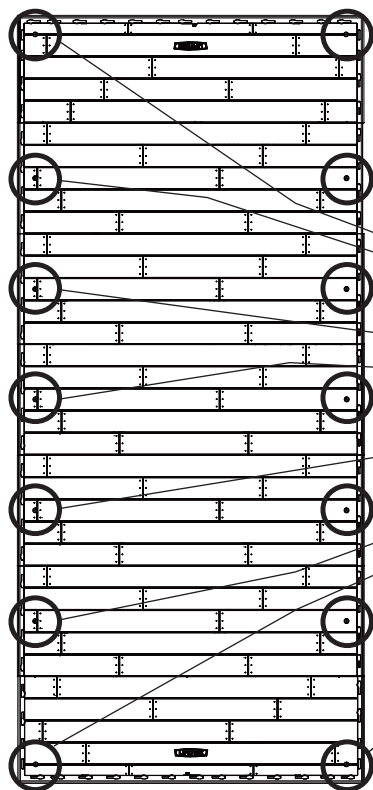

(x14)
(不隨供)



警告

如果沒有把收納屋固定好，可能發生財物毀損或人員受傷的意外。

▶ 第 14 節 (續)

對於木頭平台



5/16 in/φ
(≈8 mm)



14.1



要錨定您的儲物棚，您必須購買正確的錨定五金件。對於**木框架平台**，我們建議使用鑽、5/16 英寸 (8 毫米) 鑽頭、十四 (14) 顆 3/8 英寸 x 1 1/2 英寸 (10 毫米 x 4 釐米) 方頭螺釘和十四 (14) 顆 3/8 英寸 x 1 英寸 (10 毫米 x 2.5 釐米) 防塵墊圈。不要使用超過 3/8 英寸直徑的螺釘。有關此五金件，請查詢您當地的五金件商店。

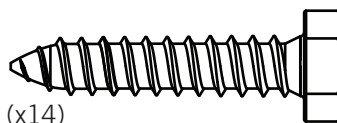
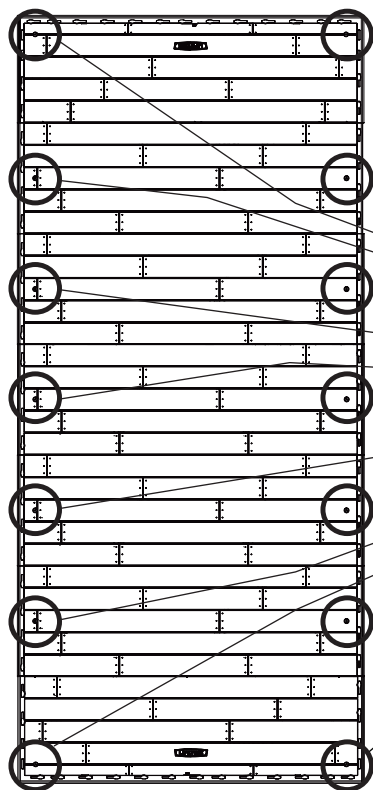

(x14)

(不隨供)

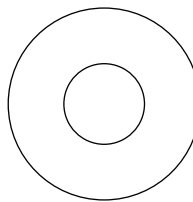

(x14)

(不隨供)



警告

如果沒有把收納屋固定好，可能發生財物毀損或人員受傷的意外。







清潔與保養

感謝您購買lifetime®產品。確實遵守以下說明，您購買的產品就能陪您渡過許多歡樂時光。

聚乙烯板可耐污漬與溶劑。用軟毛刷沾溫和肥皂刷洗板子即可清除大部分污漬。有磨砂效果的清潔材質可能會刮傷塑膠零件，因此不建議使用。如果發現金屬零件出現刮痕或生鏽，請用砂紙輕刷刮痕或生鏽處，將上面的痕跡清除後；噴上抗鏽底漆，之後再噴上高光澤度的瓷漆即大功告成。除非有使用隔熱墊，否則不要直接把會產生熱源的物品直接放在或靠近零件表面。



請上WWW.LIFETIME.COM 註冊您購買的產品

在Lifetime®，我們以供消費者創新、品質優良的產品為終極目標。上網註冊您購買的產品後，您還能把您的意見直接反映給我們。我們非常重視您提出的任何意見。

- 您也可以選擇是否願意收到新產品通知或促銷訊息。
- 如遇公司必須召回產品或發出產品安全修改的情況，我們就能利用您註冊所填寫的資料直接通知您。
- 註冊手續快速、簡單而且完全無強制性。

Lifetime 給您的承諾：

維護您的隱私安全是Lifetime®的長期政策。請您放心，Lifetime®不會將您提供的個資販售或提供給第三方，若讓第三方利用您的個資謀取利益。

歡迎您上網瀏覽我們的隱私政策：www.lifetime.com

今天就上網註冊吧！



10年有限工廠保固

如果零件沒貨或已經停產，LIFETIME® PRODUCTS, INC保留以替代方案代替保固要求的權利。

Lifetime 草坪和花園產品向原始購買者提供自原始零售購買之日起 10 年內無材料或工藝缺陷的質保。“缺陷”一詞定義為可影響產品使用的瑕疵。因誤用、濫用或疏忽而導致的缺陷將致使本質保作廢。本質保不涵蓋因安裝不當、改動或事故而致的缺陷。Lifetime 建議不要對本產品進行任何改動。本質保不涵蓋因故意破壞、生鏽、“自然之行為”、自然災害、正常磨損或任何其他製造商無法控制的事件而造成的損壞。

本質保不可轉讓，明確限制於對缺陷產品的修理或更換。如果產品在本質保的期限內出現缺陷，Lifetime Products, Inc. 將對購買者免費修理或更換缺陷零件。往返工廠或配送中心的運費不包括在內，是購買者的責任。本質保不涵蓋因拆卸、安裝或更換產品或其組件而產生的人工費用和相關費用。

本質保不涵蓋因正常使用而導致的產品刮傷、磨損或其他外觀損壞。此外，因故意損壞、疏忽或使用不當而導致的缺陷將致使本質保作廢/不在本質保範圍內。

偶然或連帶損失責任在法律所允許的範圍內被排除在外。所有商品均以這一條件出售，公司的任何代表均不得放棄或更改本政策。本產品不旨在供機構使用或商用；Lifetime Products, Inc. 對此類使用不承擔任何責任。機構或商用將致使本質保作廢。

本質保明確替代所有其他明示或暗示的保證，包括對適銷性或適用於聯邦和州法律所允許的範圍的保證。Lifetime Products, Inc. 或其任何代表均不承擔與本產品有關的任何其他責任。本質保賦予您特定的法定權利，並且您還可能擁有因所在州的不同而不同的其他權利。

我們的貨物涵蓋澳大利亞消費者法不能排除的保證。您有權對重大故障要求更換或退款，並要求對任何其他合理的可預見的損失或損害進行賠償。如果貨物的品質不達標，並且故障沒有導致重大故障，您也有權要求對貨物進行修理或更換。

**所有質保索賠均務必隨附銷售收據。
以書面形式報告產品缺陷至：**

LIFETIME PRODUCTS, INC.,
PO Box 160010
Freeport Center, Bldg. D-12
Clearfield, UT 84016-0010

有關在線質保索賠，請訪問：www.lifetime.com/warranty
質保部：(800) 225-3865 (山區標準時間 (MST) 週一-週五上午 7 點至下午 5 點)。

對於國際質保：

所有質保索賠均務必隨附銷售收據。以書面形式向您的區域銷售支持代表報告產品缺陷。請隨附您的載有日期的銷售收據和受損零件的照片。

要查找您所在地區的代表，請訪問：www.lifetime.com/international

購買配件或其他優質產品，提高您的 LIFETIME® 產品體驗

欲購買配件或其他 Lifetime® 產品，請訪問：

www.lifetime.com

或致電：1-800-424-3865

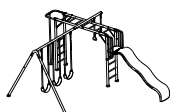

中国 制造