

戶外涼亭

貨號: 2127281

型號: A102010800

Outdoor Gazebo

ITM. / ART. 2127281

MODEL# A102010800

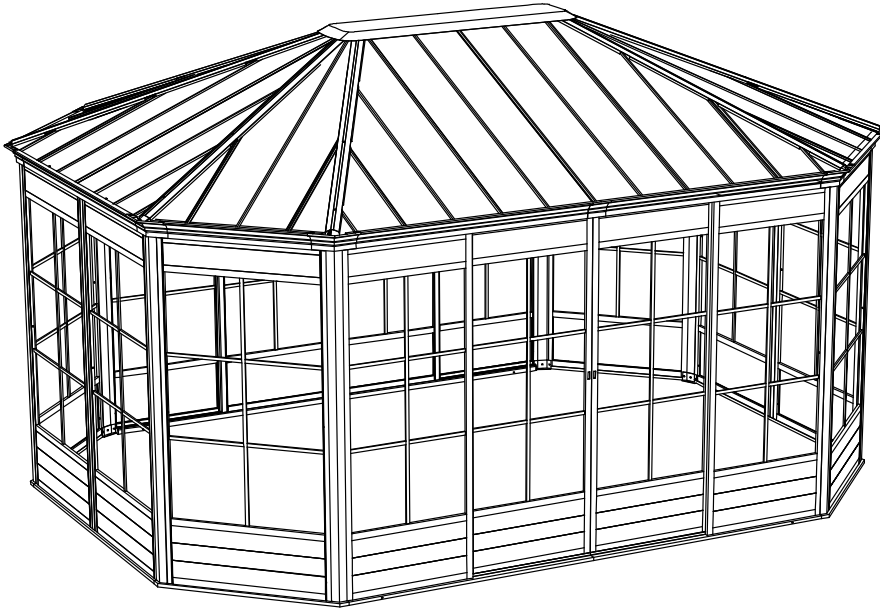

重要：請保留說明書，並仔細閱讀。

請在組裝前與您當地的管理機構/當地市政法規核對有關結構安裝的信息。

IMPORTANT, RETAIN FOR FUTURE REFERENCE: READ CAREFULLY.

Please check with your local governing authority / local municipal codes regarding installation of structures before assembly.

安全設備需求 (不包括在內)
Safety Items required (Not Included)

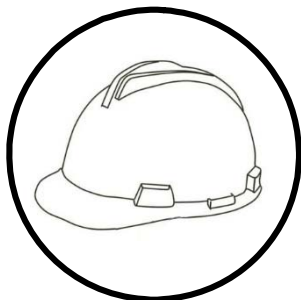

所需工具 (不包括在內)
Tools Needed (Not Included)

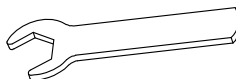
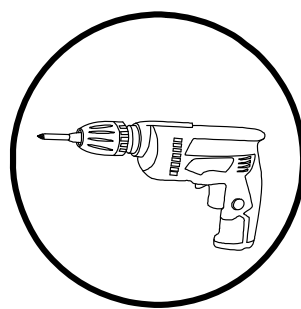
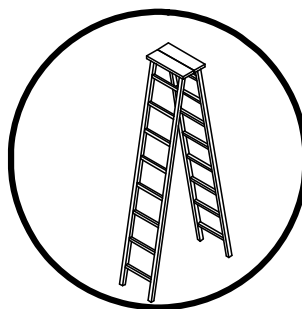
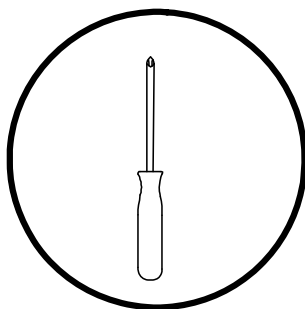
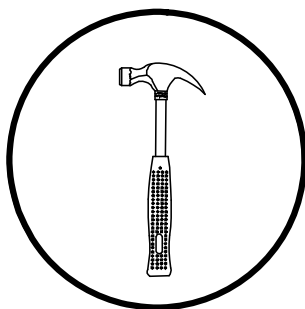

包含在內
Included

警告：

- 組裝前檢查以確保所有零件都齊全。
- **這個產品很重！至少需要 4 名成人才能安全組裝。切勿單獨組裝本裝置！**
- 讓所有兒童和寵物遠離安裝區域。兒童和寵物在涼亭建築區域內時應該被監督。
- 使裝配區與任何障礙物（例如圍欄、車庫、房屋、懸垂的樹枝、洗衣線或電線）保持 1.8 m / 5.9 ft 以上的距離。
- 某些零件可能包含鋒利的邊緣。在組裝和使用本產品時，應始終遵循基本的安全預防措施，以減少人身傷害和產品損壞的風險。請在組裝和使用前閱讀所有說明。
- 僅限戶外使用。使用前檢查所有螺栓是否擰緊，並根據需要定期檢查和擰緊螺栓。
- 只能在堅固、平坦的地面或堅硬的表面上組裝本裝置。確保設備在最終組裝後處於水平狀態。
- 不要將涼亭安裝在沙質、泥濘或鬆散的土壤上，因為木樁（不包括在內）在這些類型的土壤中沒有足夠的錨固。
- 如果您希望將涼亭固定在木甲板或混凝土表面上，請適當使用這些表面的錨栓。
- 清除屋頂上所有多餘的雪。
- 為避免損壞，請使用塑料雪耙清除屋頂上過多的積雪和冰，並遠離掉落的碎片。
- 請勿將涼亭置於風大的地方，否則可能會損壞結構。
- 產品的任何組裝或維護只能由成人進行。
- 在組裝過程中保護零件，將它們放置在無磨損的表面上，例如毯子或紙板。

WARNING:

- Check to ensure all parts are present prior to assembly.
- **This unit is heavy! At least 4 adults are needed for safe assembly. Never assemble this unit alone!**
- Keep all children and pets away from assembly area. Children and pets should be supervised when they are in the area of the gazebo construction.
- Keep assembly area more than 1.8 m / 5.9 ft from any obstruction such as a fence, garage, house, overhanging branches, laundry line or electrical wires.
- Some parts may contain sharp edges. When assembling and using this product, basic safety precautions should always be followed to reduce the risk of personal injury and damage to the product. Please read all instructions before assembly and use.
- For outdoor use only. Check all bolts for tightness before use and periodically check and tighten bolts as necessary.
- Assemble this unit on firm, level ground or hard surface only. Ensure the unit is level after final assembly.
- Do not assemble the gazebo on sandy, muddy or loose soil, as stakes (not included) do not have enough anchorage in these types of soil.
- If you wish to secure the gazebo to a wood deck or concrete surface, use anchors suited to these surfaces.
- Remove all excess snow from the roof.
- In order to avoid damage, use a plastic snow rake to remove excessive snow and ice buildup from roof and keep away from falling debris.
- Do not leave the gazebo where there is a risk of high wind, as possible damage will occur to the structure.
- Any assembly or maintenance of the product must be carried out by adults only.
- Protect parts during assembly by laying them on a non-abrasive surface such as blankets or cardboard.

使用說明：

- 該涼亭的鋼部件經過防銹漆處理，可防止其生鏽。但是，由於鋼的性質，如果這些保護塗層被劃傷，就會發生表面氧化（生鏽）。這不是缺陷，因此不在保修範圍內。
- 為盡量減少這種情況，建議在組裝和處理產品時小心謹慎，以免刮傷油漆。如果發生任何划痕或損壞，建議立即用防銹漆（不包括在內）覆蓋划痕。
- 表面的鏽跡也可以通過少量塗抹普通食用油或 WD-40 輕鬆去除。如果發生表面氧化（生鏽）並且沒有採取措施防止這種情況發生，氧化作用可能會開始滴落到甲板或露台上，並導致難以去除的破壞性污漬。如果採取上述措施防止產品氧化，則可以防止這種情況發生。
- 請勿在屋頂或框架部件上使用漂白劑、酸或其他研磨性清潔劑。
- 保留使用說明書以備將來參考。
- 定期檢查並確保所有螺栓在使用過程中緊固良好。

CARE INSTRUCTIONS:

- Steel components for this gazebo are treated with rust inhibiting paint that protects it from rusting. However, due to the nature of steel, surface oxidation (rusting) will occur if these protective coatings are scratched. This is not a defect and thus not covered by the warranty.
- To minimize this condition, it is recommended to use care when assembling and handling the product to prevent scratching the paint. Should any scratching or damage occur, it is recommended to cover the scratch immediately with rust inhibiting paint (not included).
- Surface rust can also be easily removed with a very light application of regular cooking oil or WD-40. If surface oxidation (rusting) occurs and if no measure is taken to prevent this, the oxidation may start dripping onto deck or patio and caused damaging stains, which may be difficult to remove. This can be prevented if the above-mentioned measures are taken to keep the product from oxidizing.
- Do not use bleach, acid, or other abrasive cleaners on the roof or frame parts.
- Keep instruction manual for future reference.
- Periodically check and ensure that all bolts are well-tighten during use.

TWO-YEAR LIMITED WARRANTY

This limited warranty is extended to the original purchaser and applies to defects in material and workmanship of your item provided the item is maintained with care and used only for personal, residential purposes. The manufacturer warrants this item is free of defects in material and workmanship for a period of two years. If any defect is found, please call our customer service department at 1-866-578-0101 or email at costco@sunjoygroup.com for help. The manufacturer will not cover transportation or delivery costs or compensate the individual or any outside party for assembling or disassembling the product.





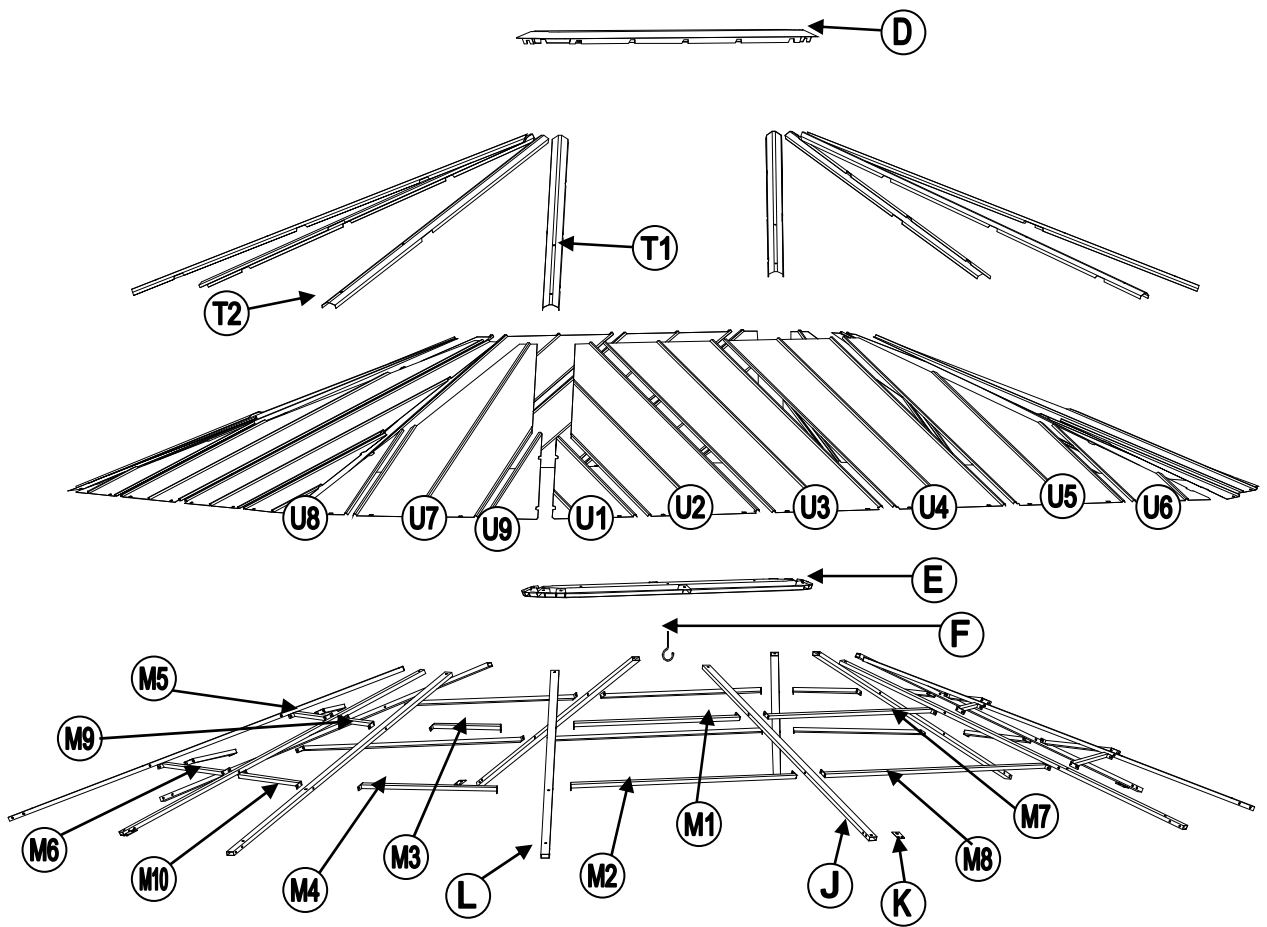

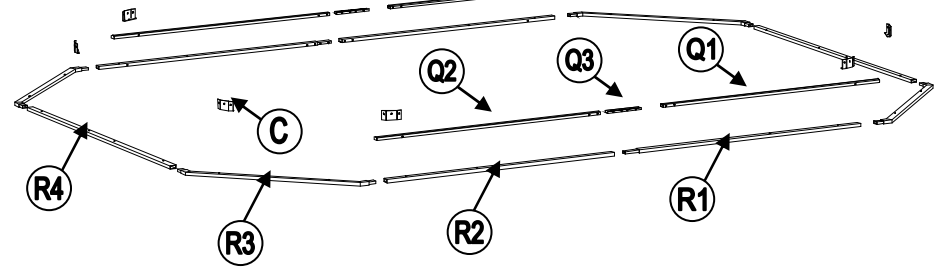
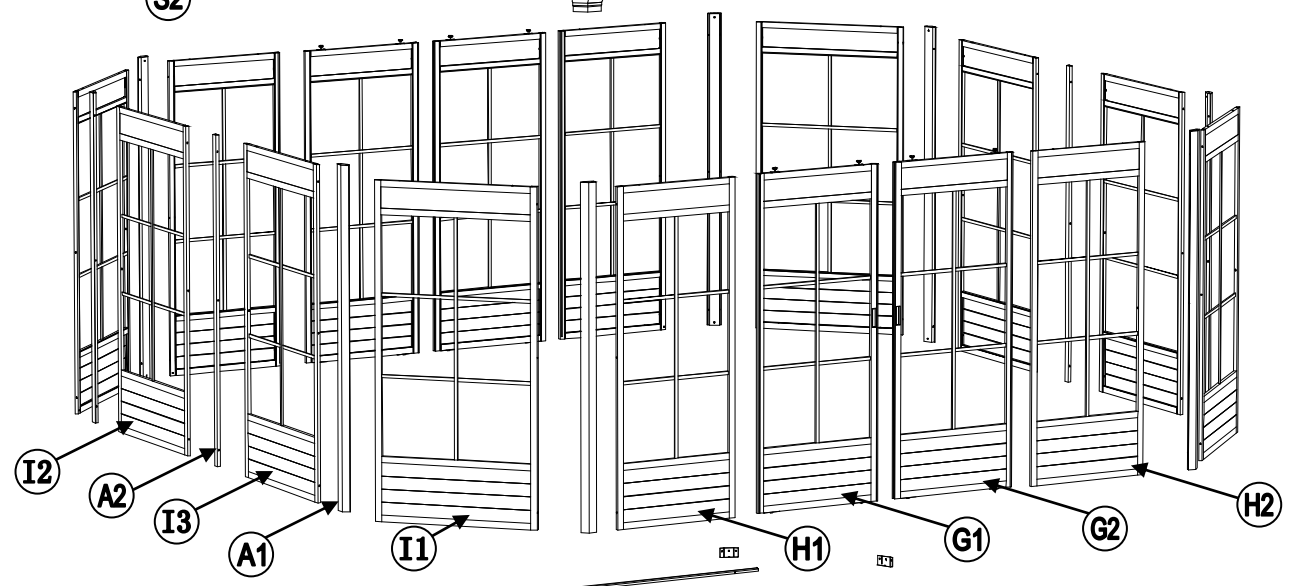
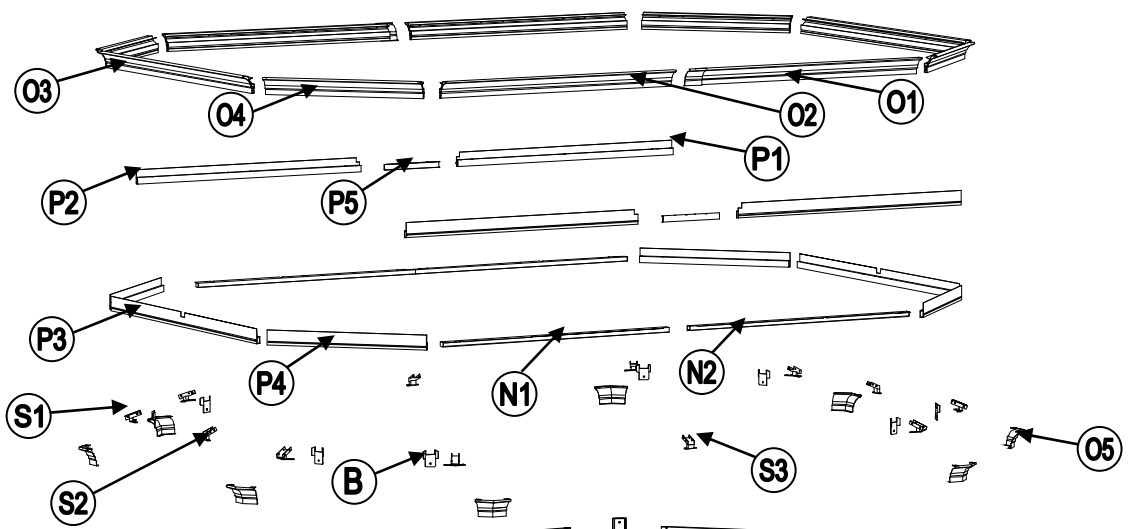







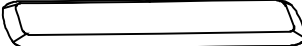

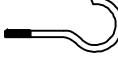

AUSTRALIA: Our goods come with guarantees that cannot be excluded under the Australian Consumer Law. You are entitled to a replacement or refund for a major failure and for compensation for any other reasonably foreseeable loss or damage. You are also entitled to have the goods repaired or replaced if the goods fail to be of acceptable quality and the failure does not amount to a major failure.











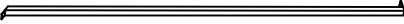

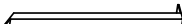

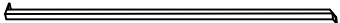

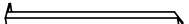

分解圖
Exploded Drawing















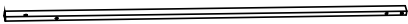







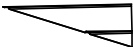

零件清單
Parts List

編碼 Lable	售服編碼 Part Number	數量 Qty	零件圖片 Part Image
A1	P000200525	8	
A2	P000200526	2	
B	P002200308	8	
C	P000100393	8	
D	P000900140	1	
E	P000501443	1	
F	P005800001	1	
G1	P000401008	2	
G2	P000401009	2	
H1	P000401010	2	
H2	P000401011	2	
I1	P000401012	4	
I2	P000401013	2	
I3	P000401014	2	
J	P000601756	4	
K	P000501444	4	
L	P000601757	8	
M1	P000601758	2	





M2	P000601759	2	
M3	P000601760	4	
M4	P000601761	4	
M5	P000601762	2	
M6	P000601763	2	
M7	P000601895	2	
M8	P000601897	2	
M9	P000601896	2	
M10	P000601898	2	
N1	P005700756	2	
N2	P005700757	2	
O1	P005600413	2	
O2	P005600414	2	
O3	P005600415	2	
O4	P005600417	4	
O5	P000401015	8	
P1	P005000509	2	
P2	P005000510	2	
P3	P005600416	2	
P4	P005000511	4	

P5	P000501445	2	
Q1	P005700759	2	
Q2	P005700758	2	
Q3	P000501446	2	
R1	P005700760	2	
R2	P005700761	2	
R3	P005700762	4	
R4	P005700763	2	
S1	P000501447	4	
S2	P000501448	4	
S3	P000501449	4	
T1	P000800307	4	
T2	P000800308	4	
U1	P000700838	4	
U2	P000700840	4	
U3	P000700842	2	
U4	P000700843	2	
U5	P000700841	4	
U6	P000700839	4	

U7	P000700844	4	
U8	P000700845	4	
U9	P000700846	4	

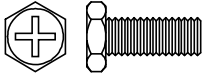
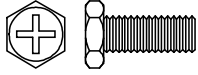
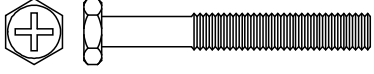
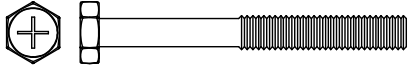
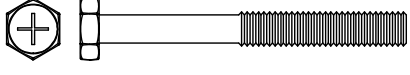
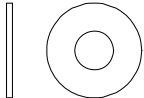
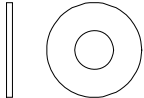
零件清單

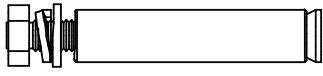
Hardware Pack

編碼 Label	售服編碼 Part Number	零件名稱 Description	數量 Qty	備用 Spare	零件圖片 Part Image
AA	H010020008	螺栓 M6*15 Bolt M6*15	178	9	
BB	H010020155	螺栓 M6*15(SS) Bolt M6*15(SS)	48	3	
CC	H010020006	螺栓 M6*45 Bolt M6*45	16	1	
DD	H010020007	螺栓 M6*55 Bolt M6*55	24	2	
EE	H010020199	螺栓 M6*55 (SS) Bolt M6*55 (SS)	116	6	
FF	H050080006	平墊圈 M6 Flat washer M6	242	13	
GG	H050080021	平墊圈 M6 (SS) Flat washer M6 (SS)	164	9	
HH	H040100003	螺母 M6 Nut M6	24	2	
II	H010100002	膨脹螺栓 $\Phi 6*80$ Expansion Bolt $\Phi 6*80$	8	0	
Z	H090010017	扳手 M6 Wrench M6	2	0	

1

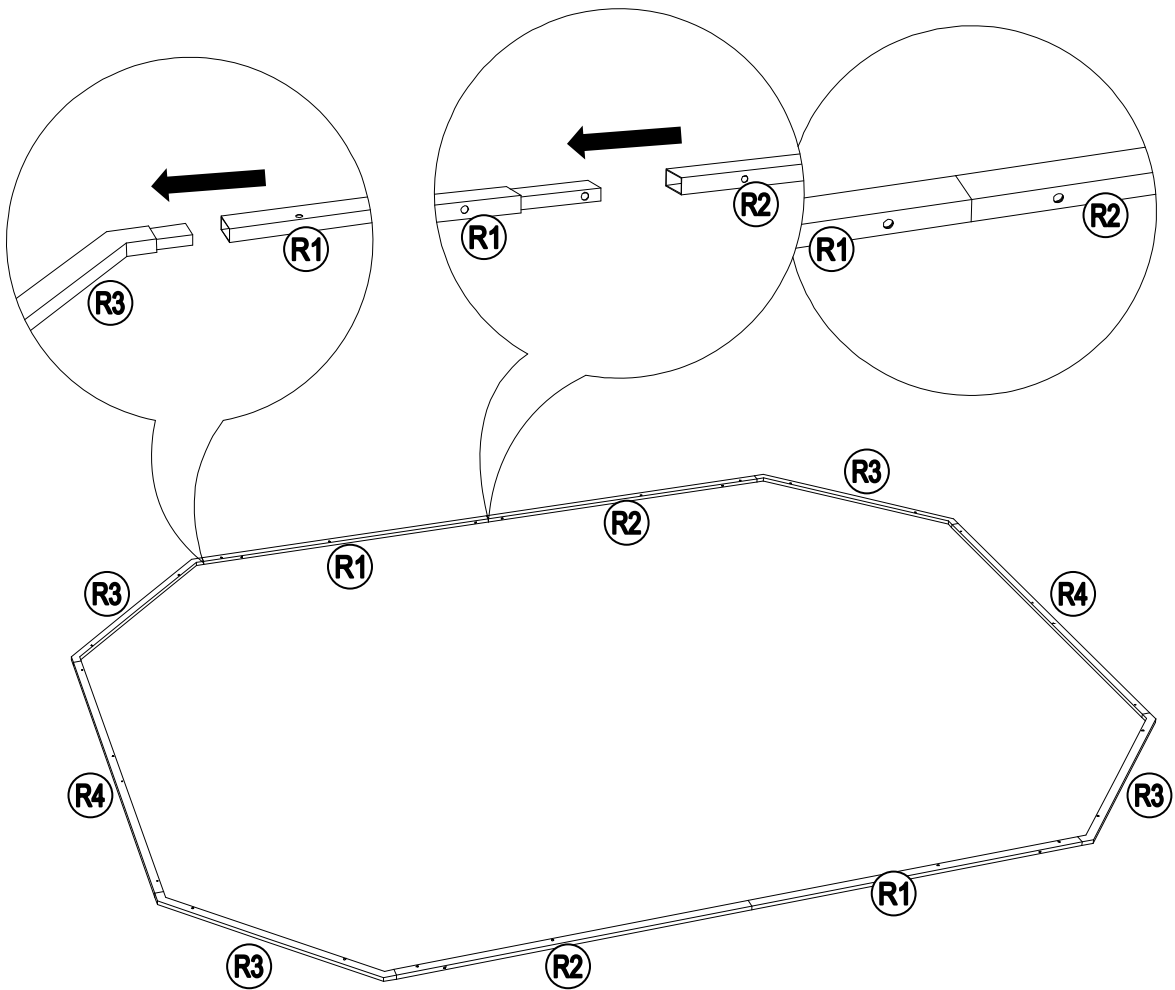
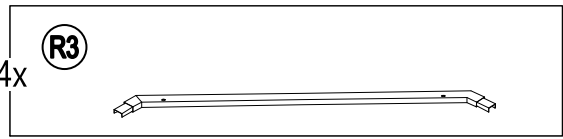
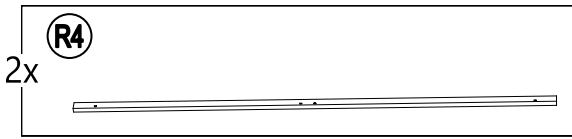
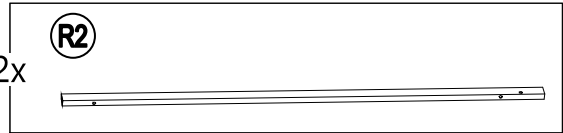
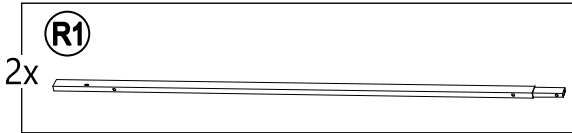

2

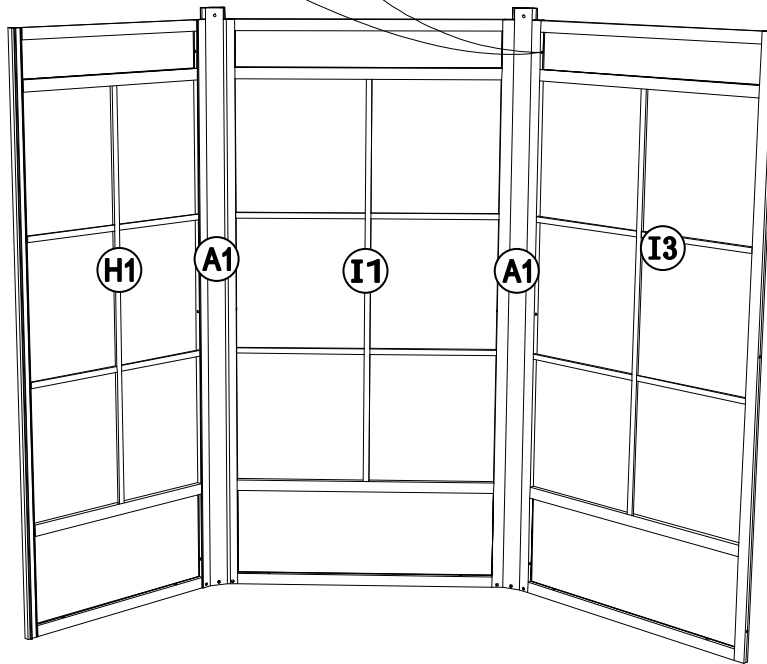
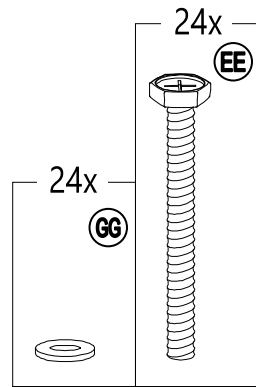
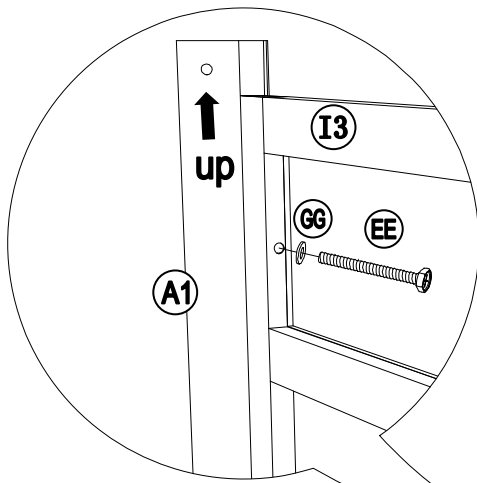
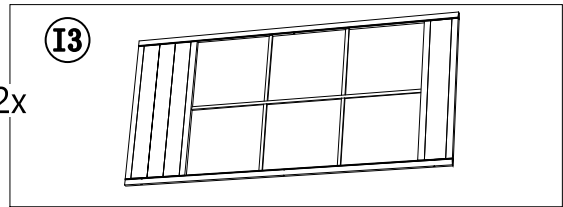
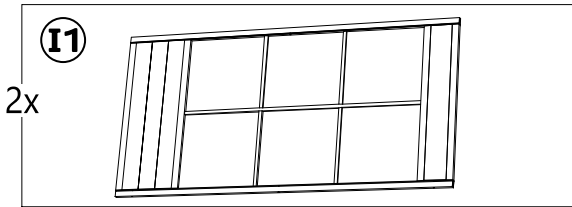
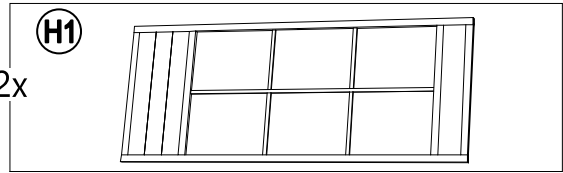
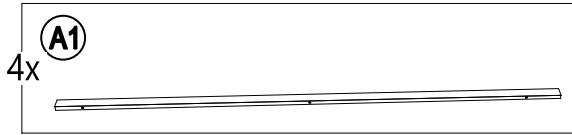

3

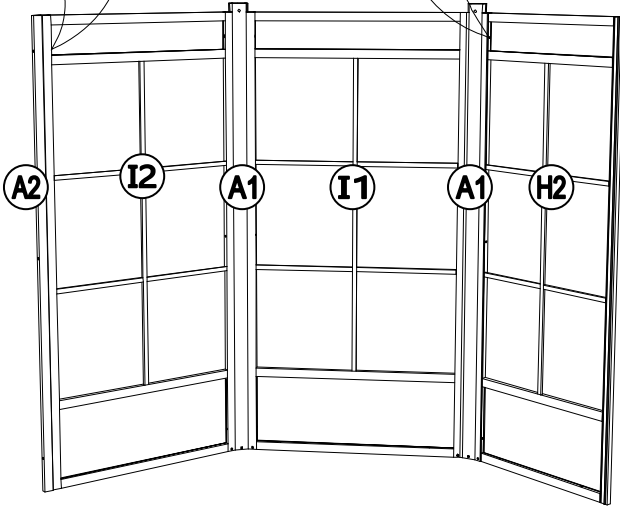
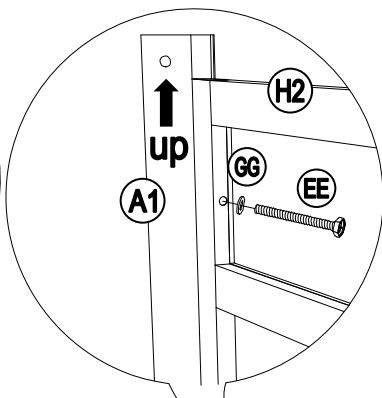
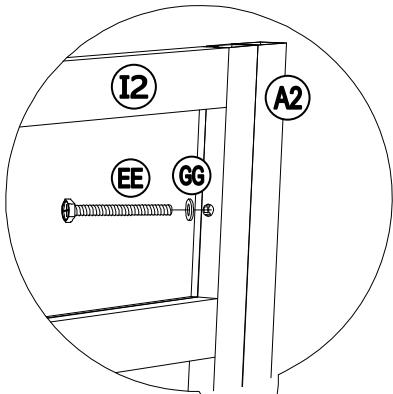
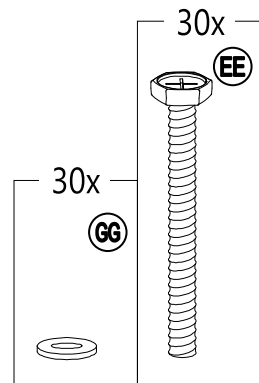
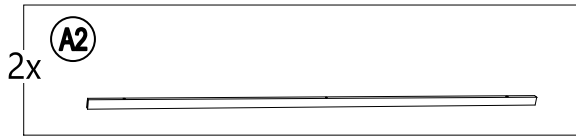
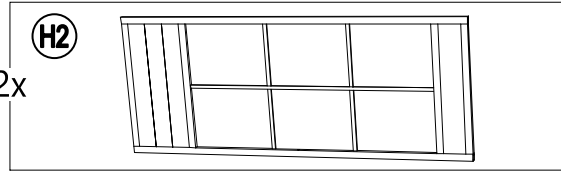
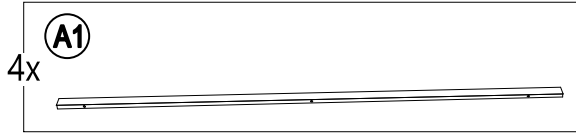
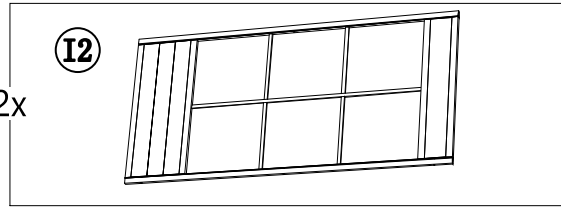
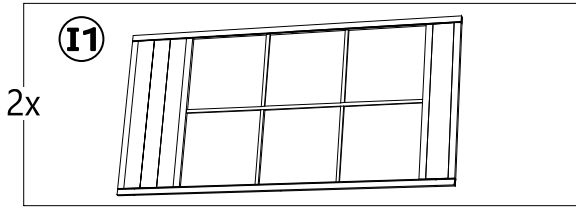

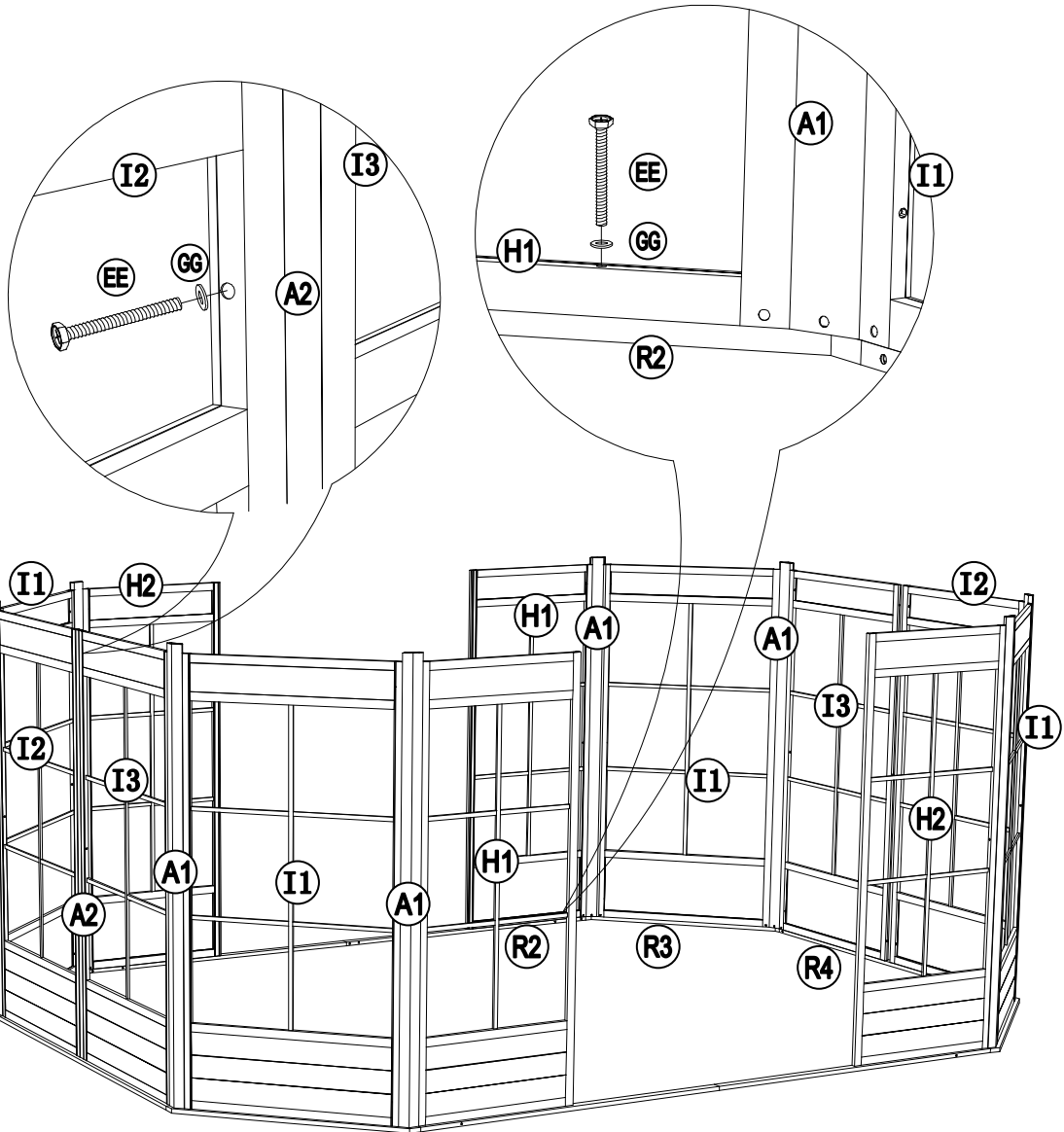
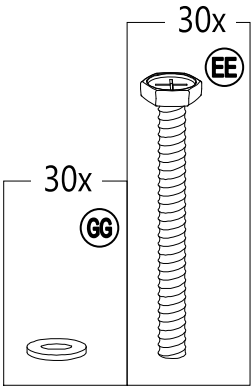

5

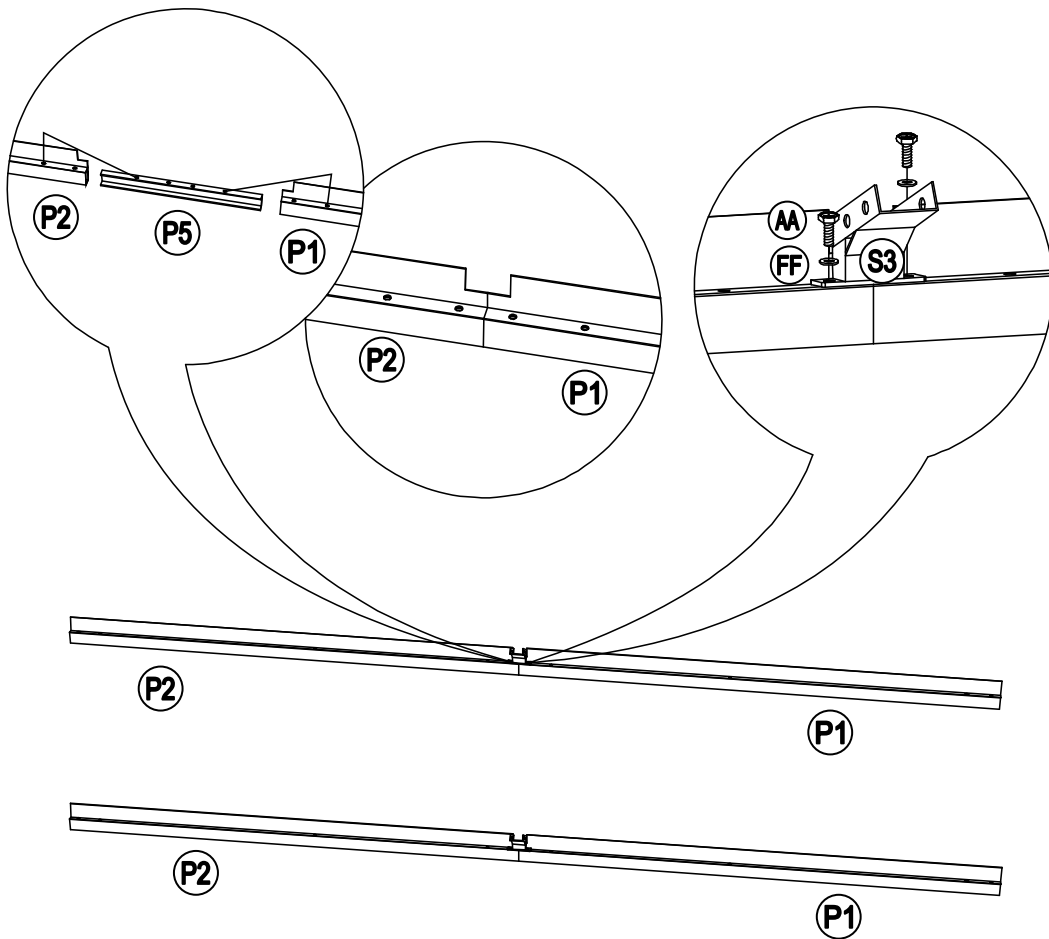
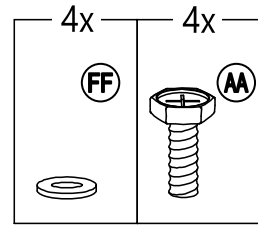
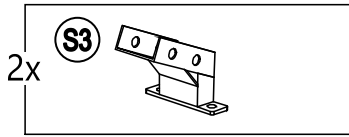
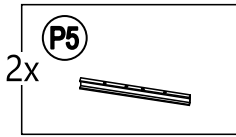
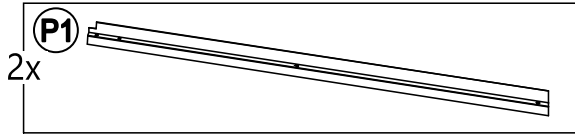
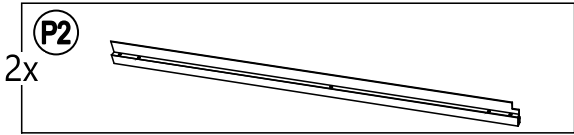

6

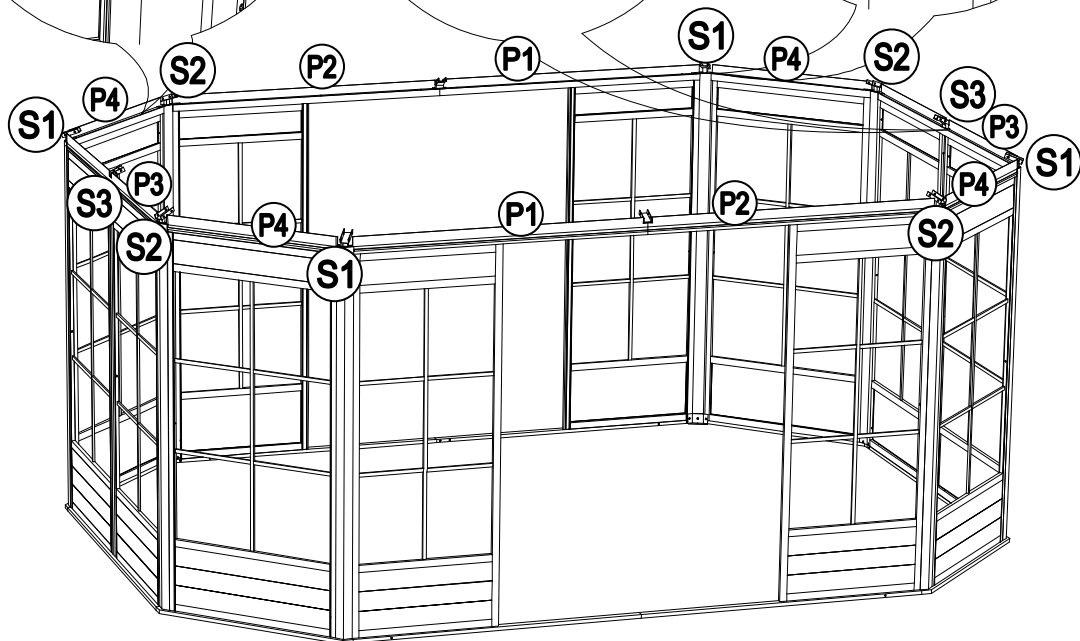
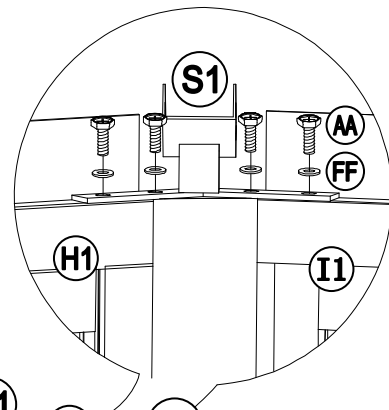
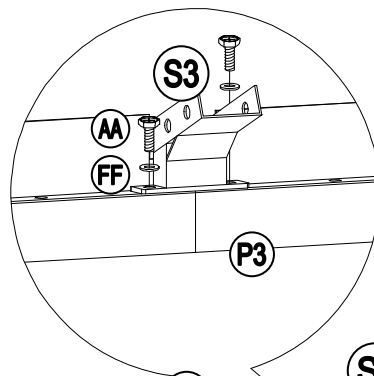
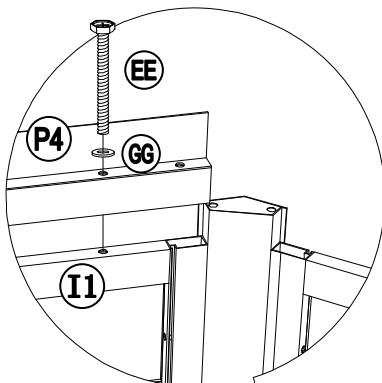
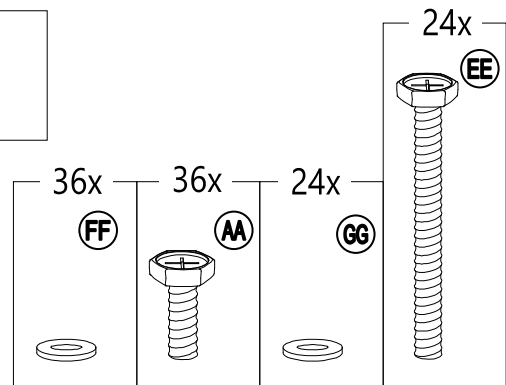
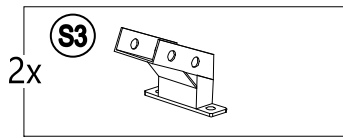
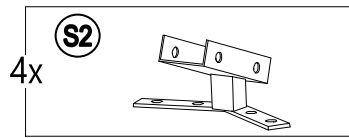
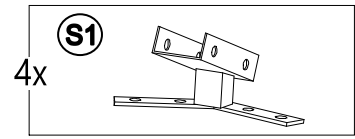
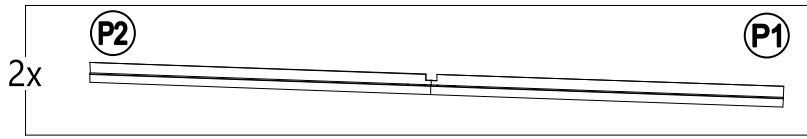
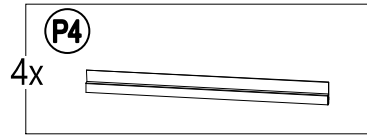
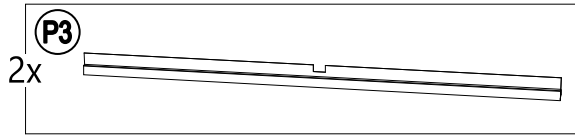

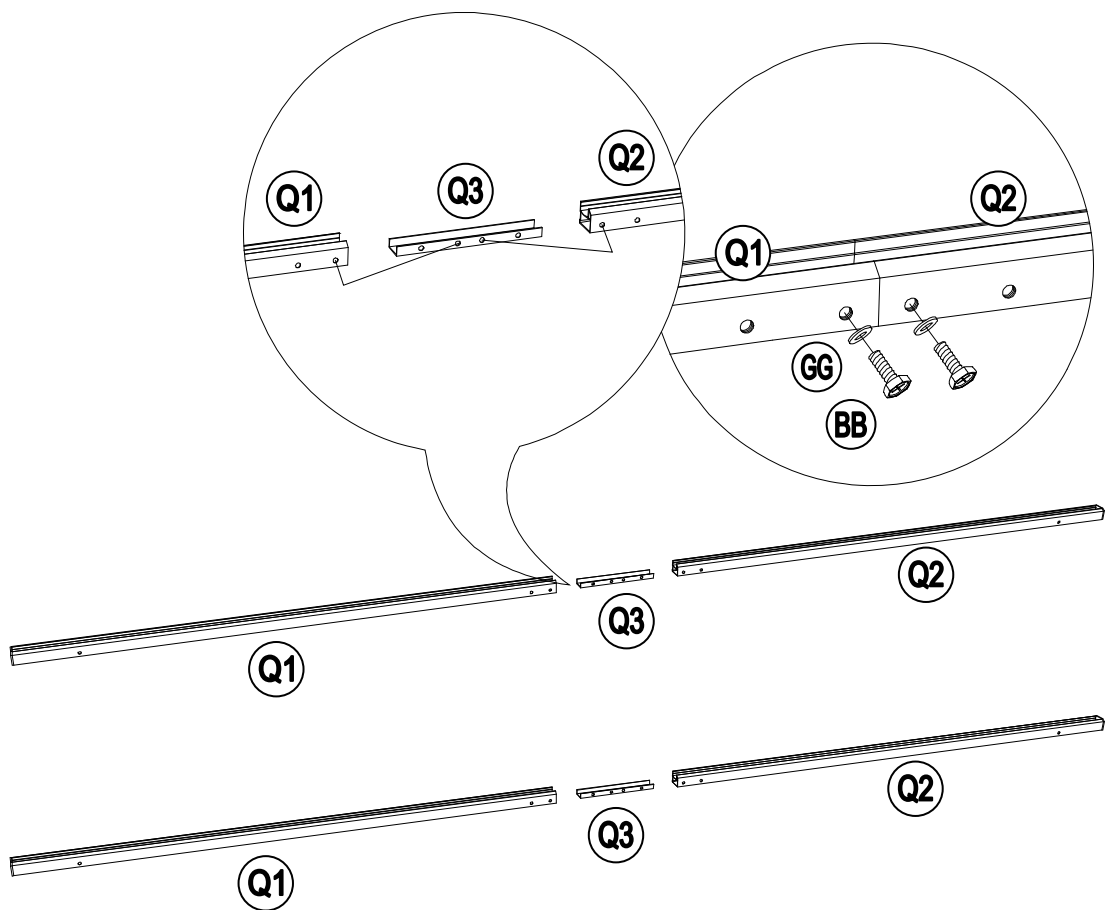
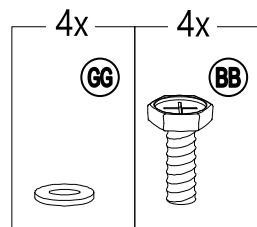
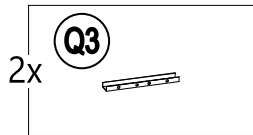
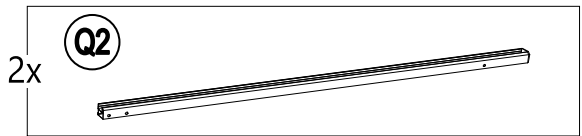
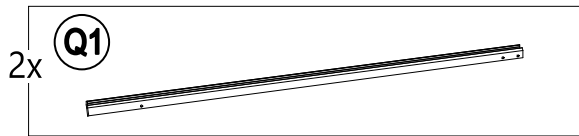

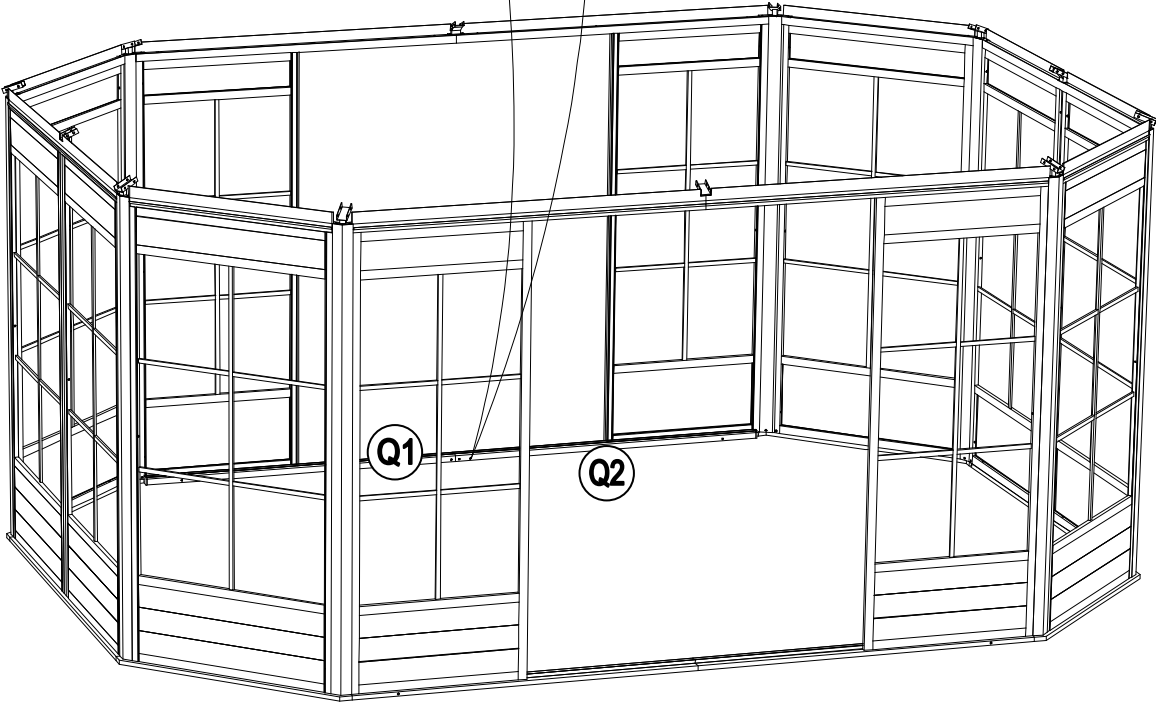
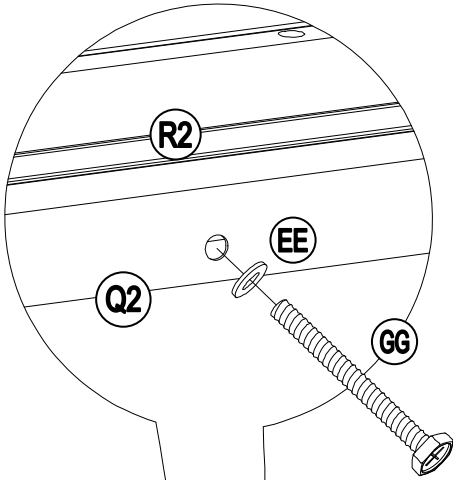
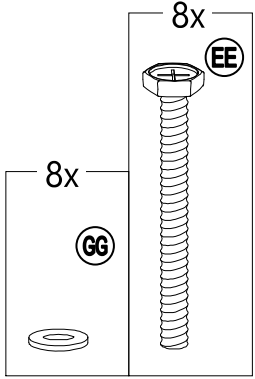
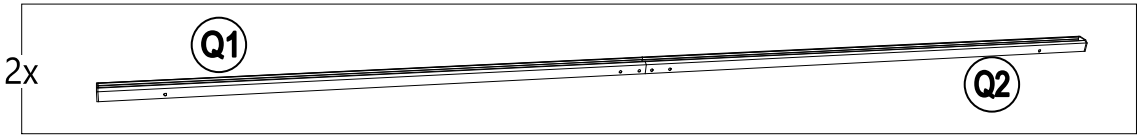

9

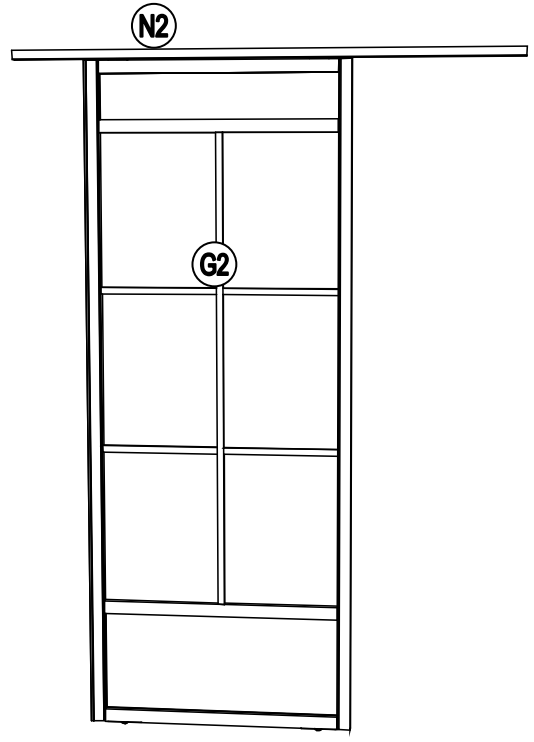
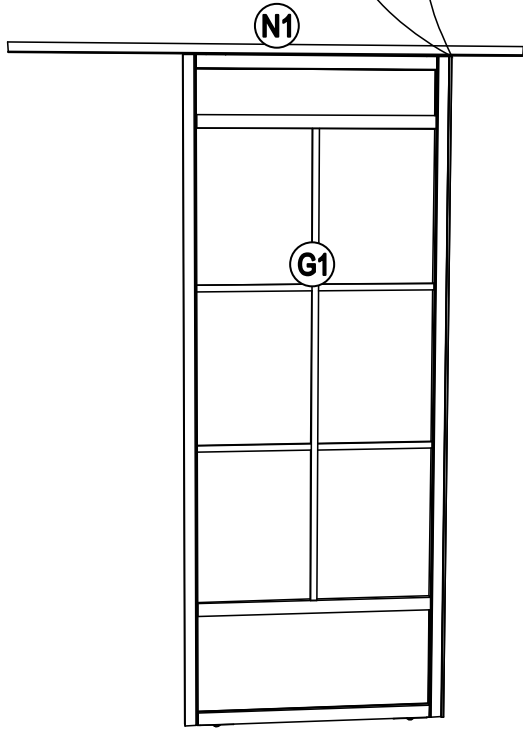
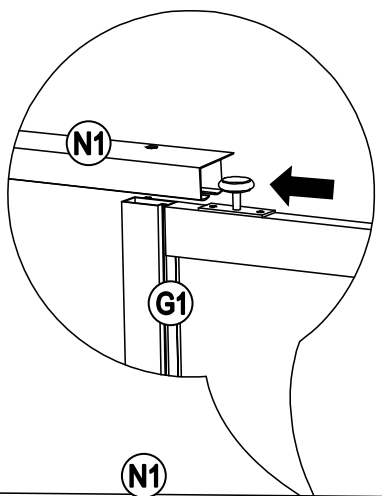
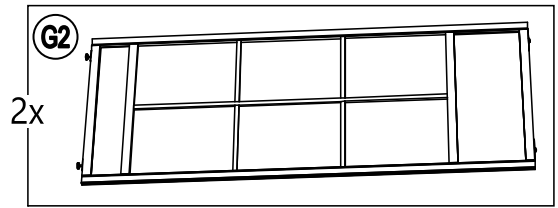
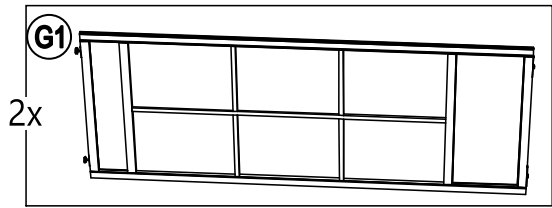
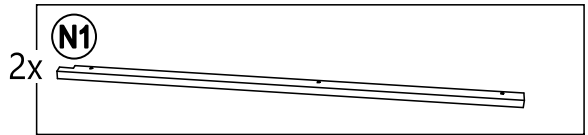
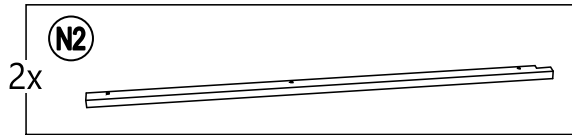

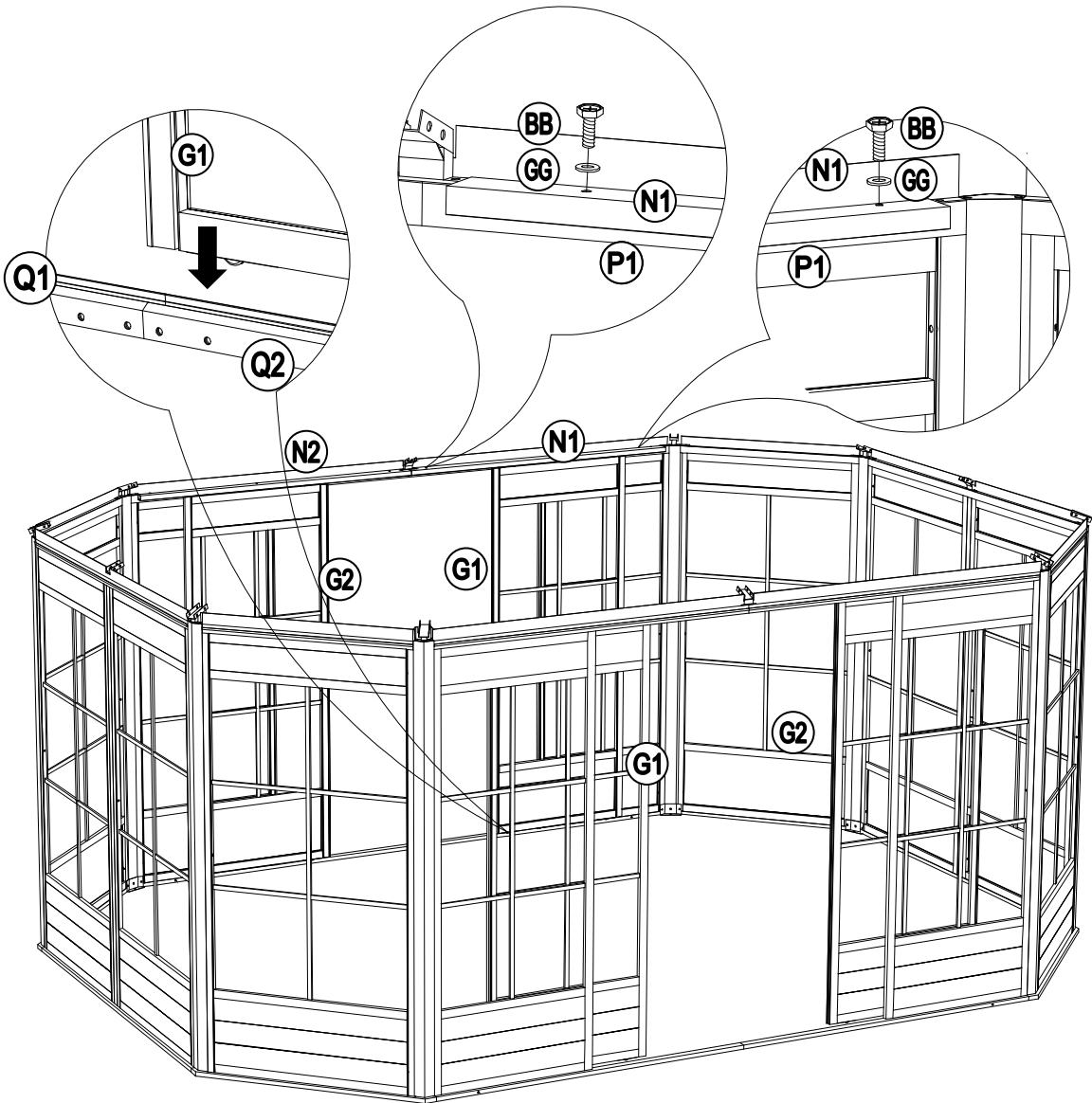
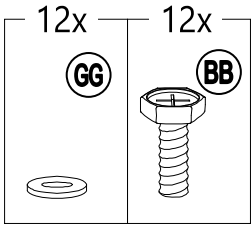

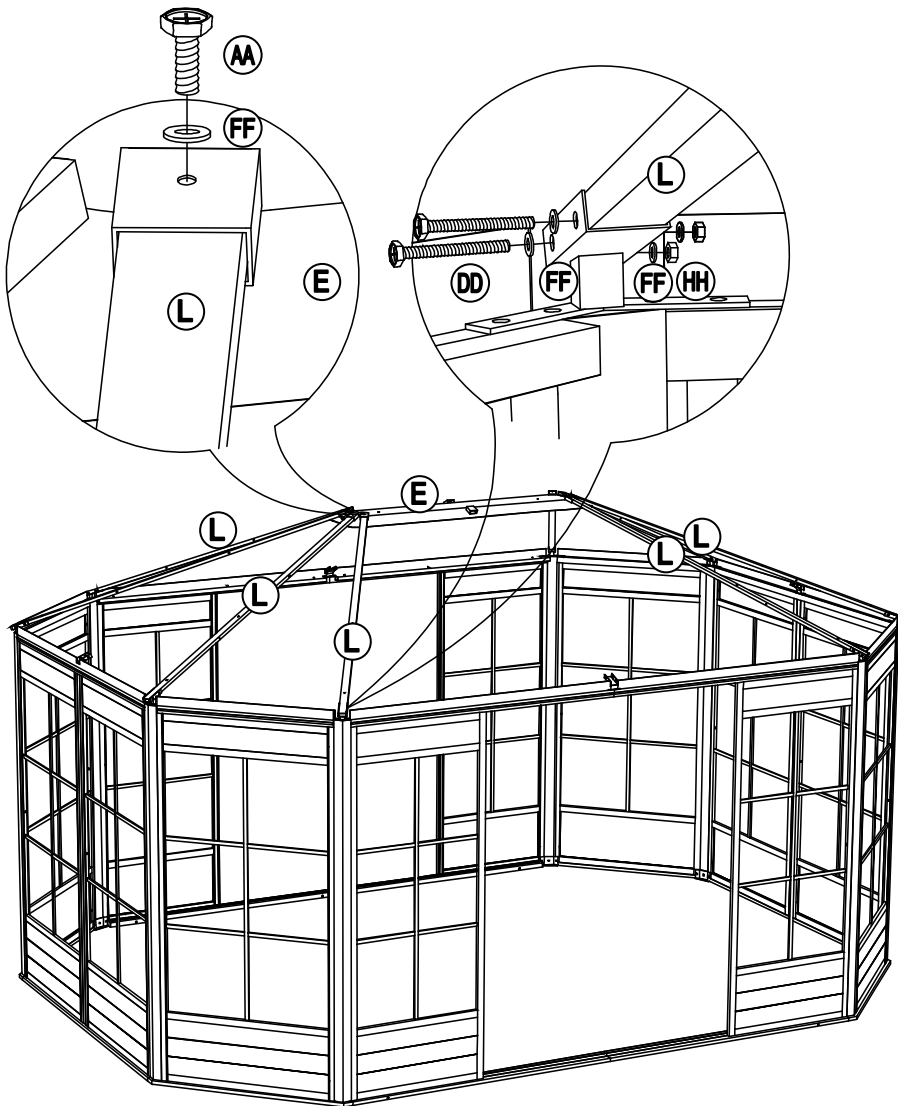
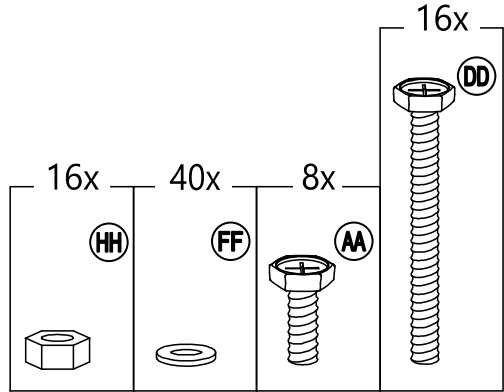
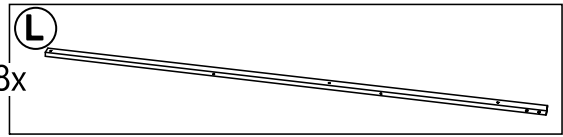
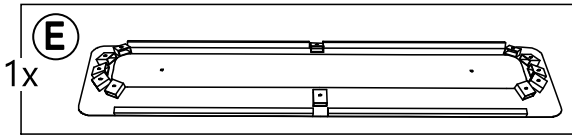

12

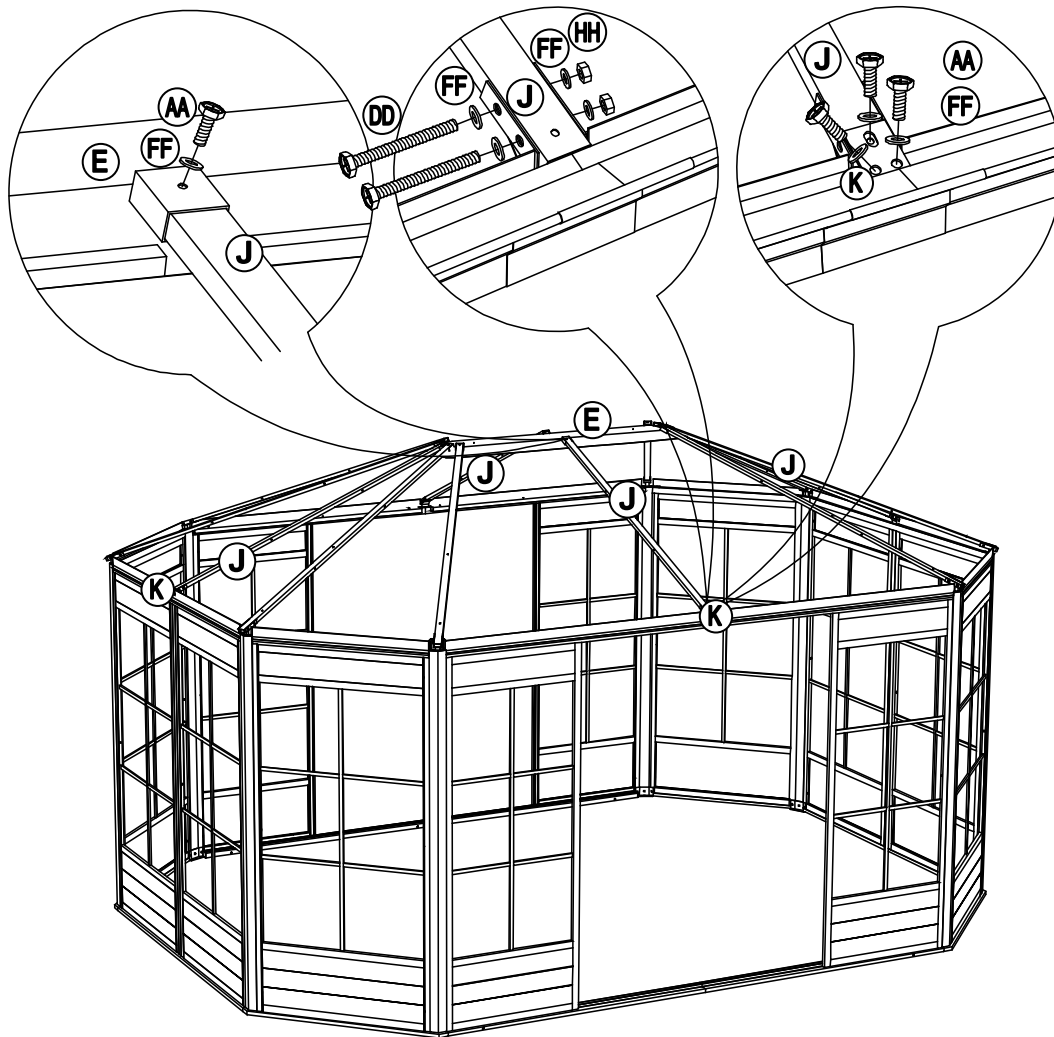
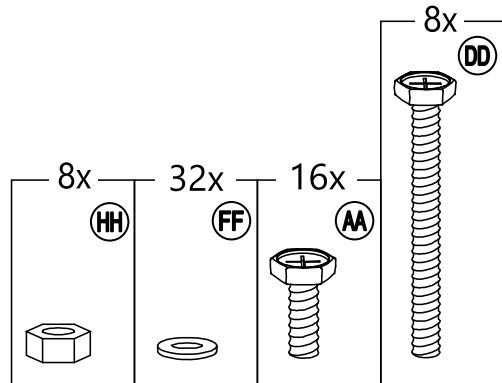
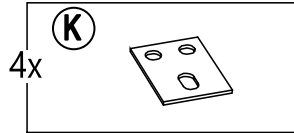
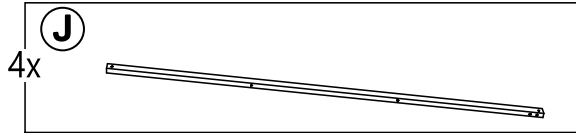

13

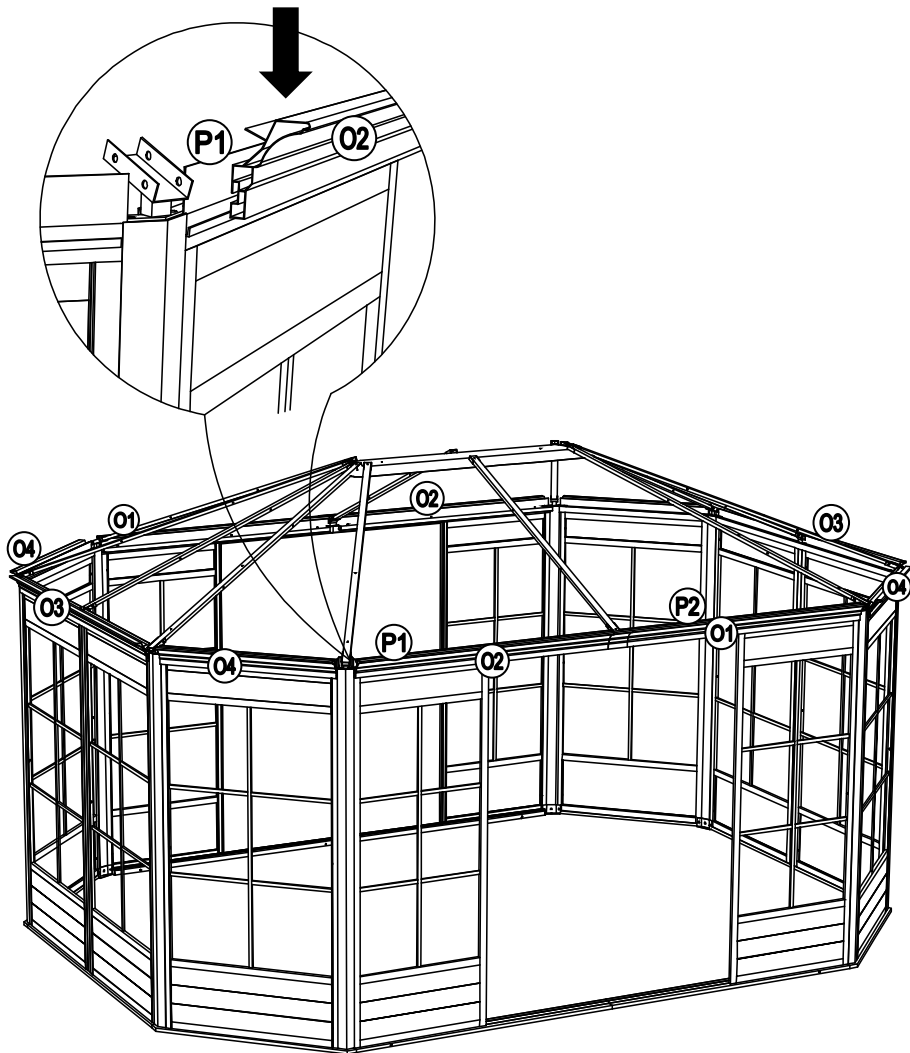
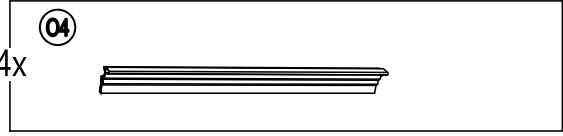
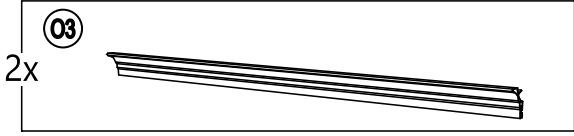
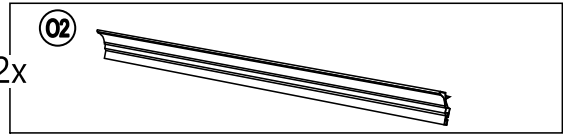
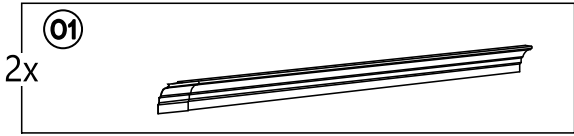

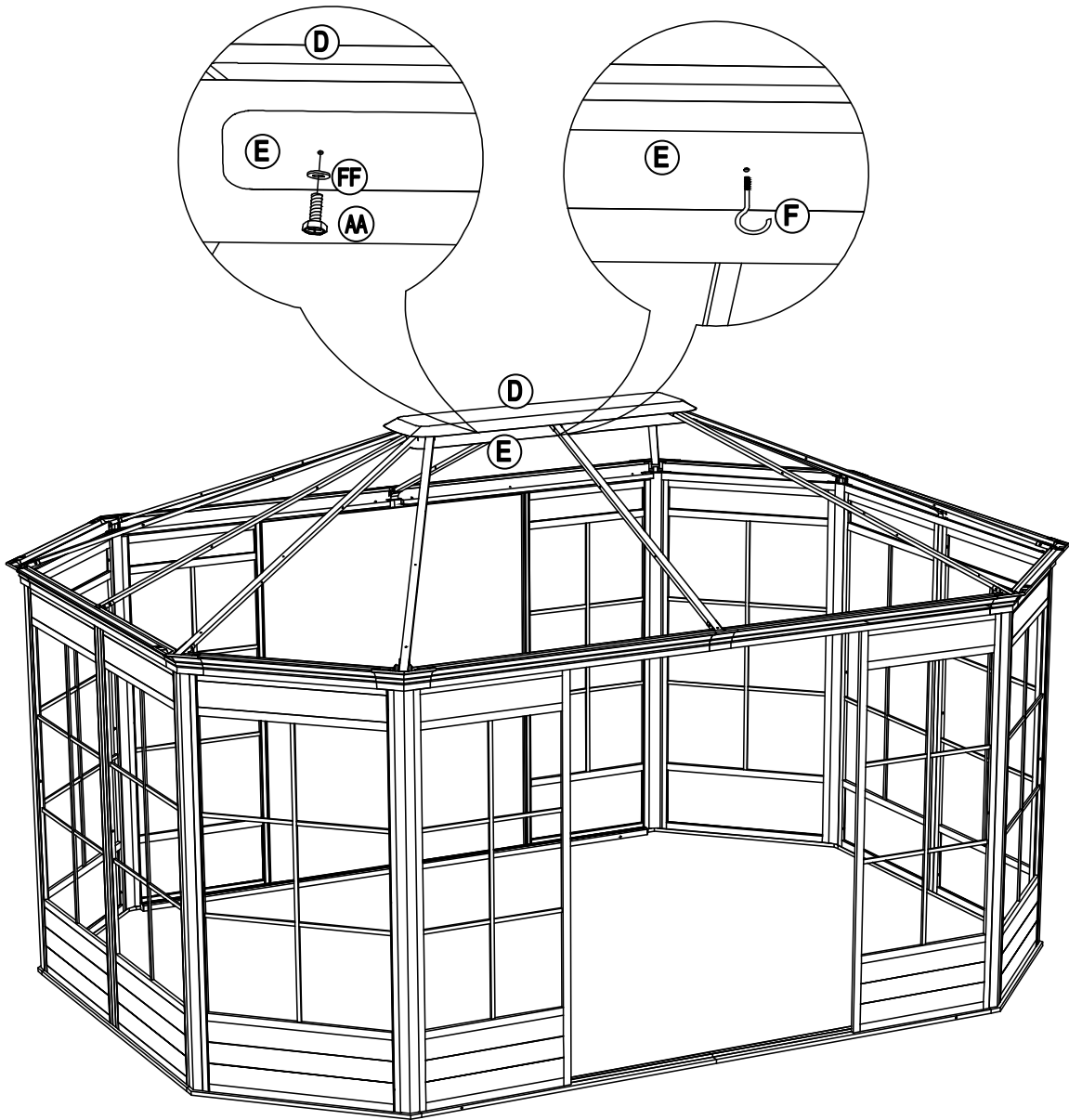
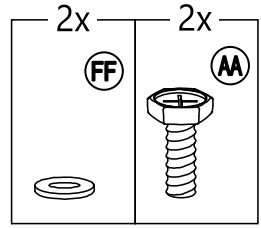
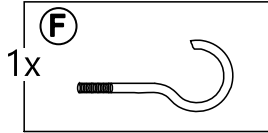
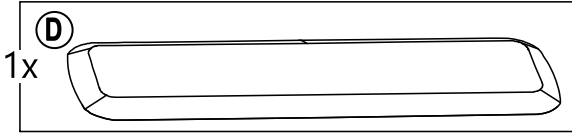

16

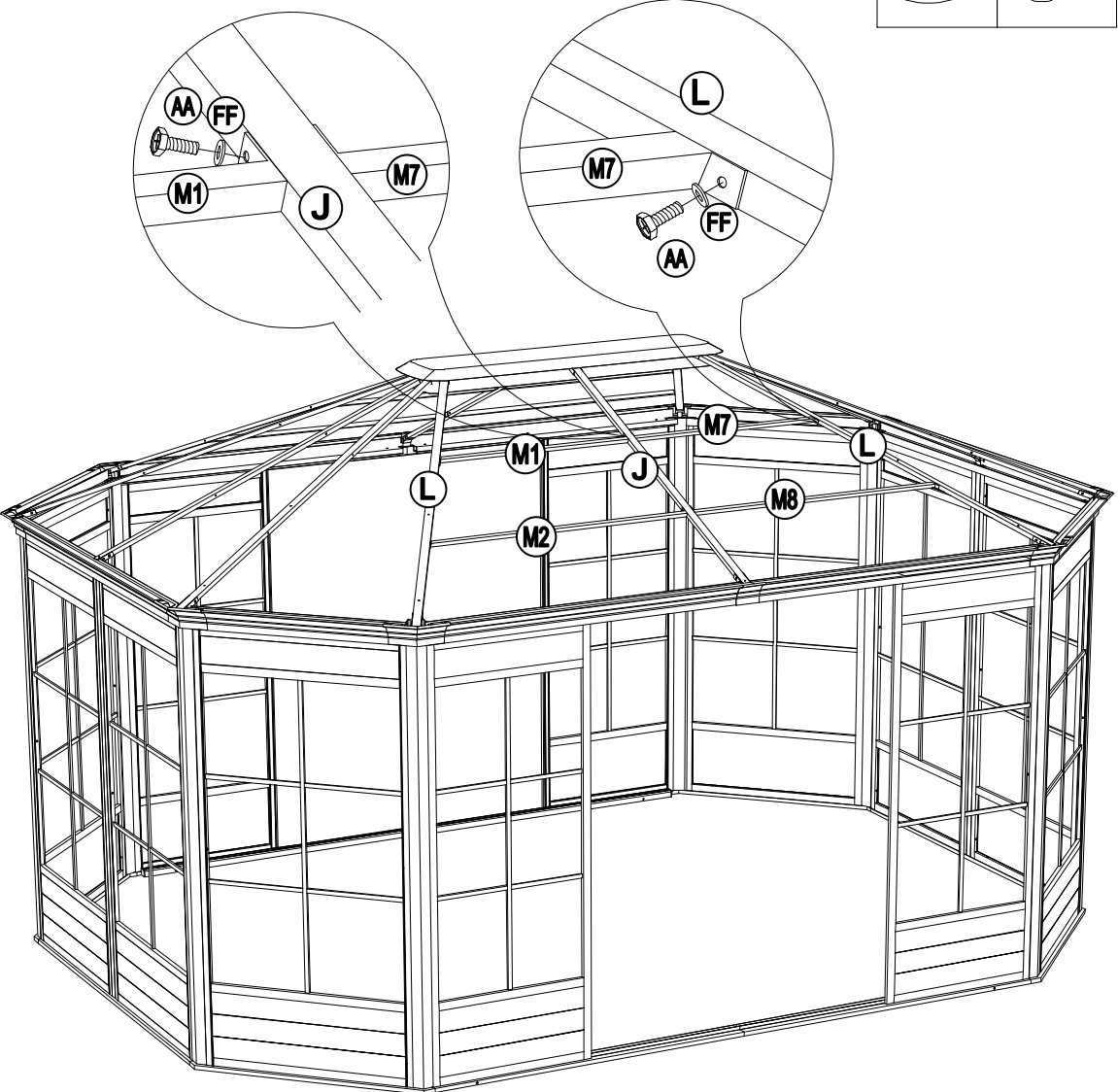
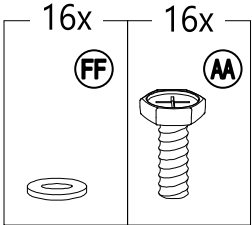
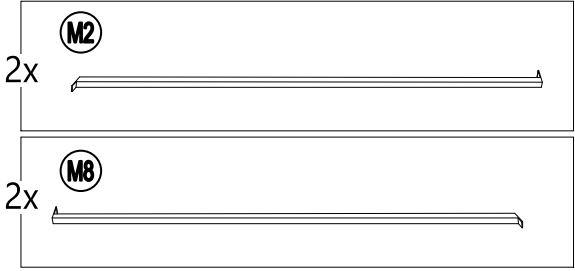
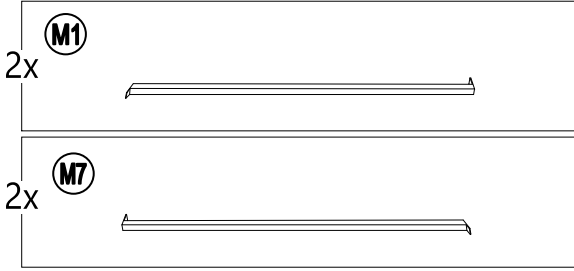

17

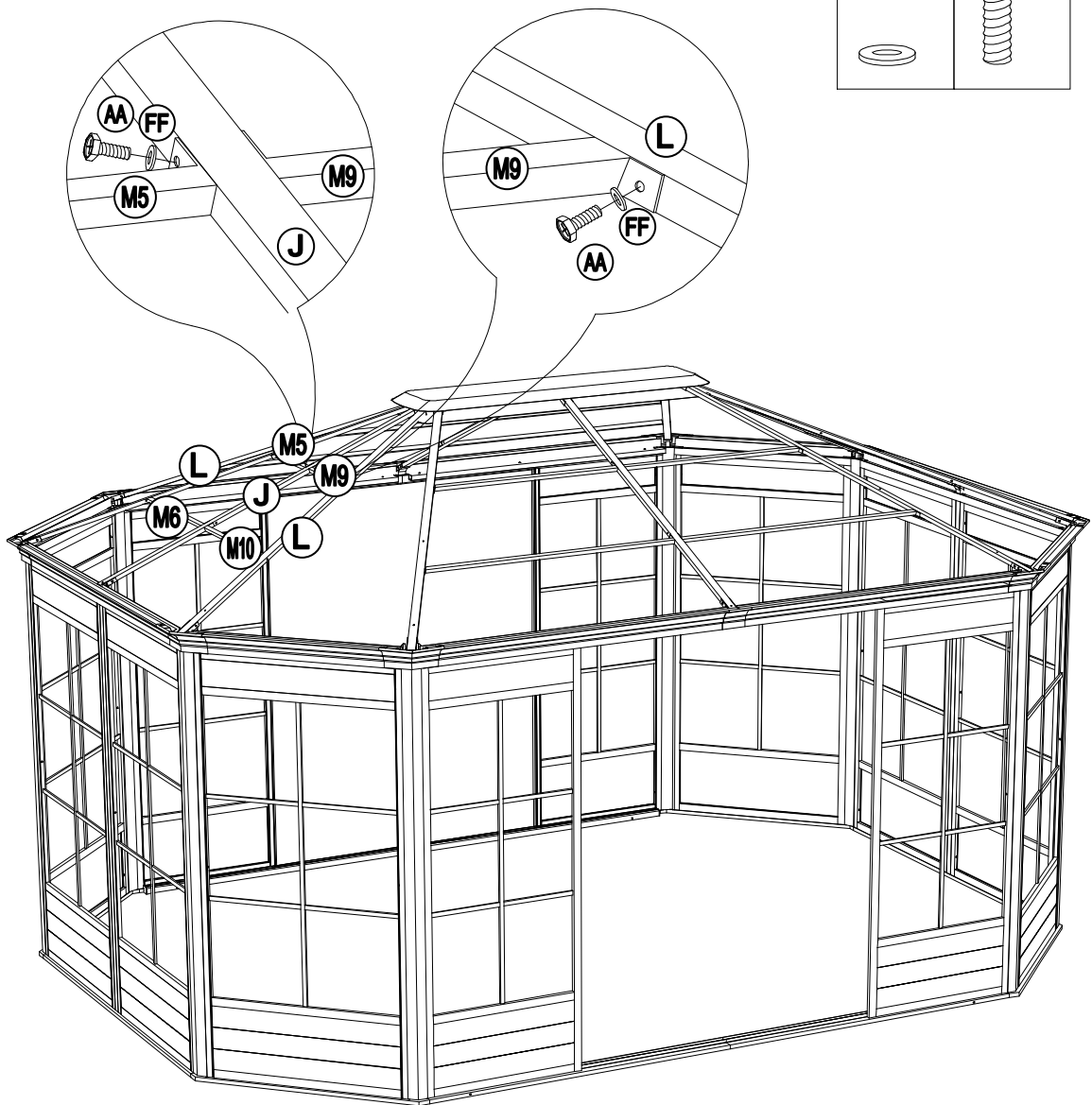
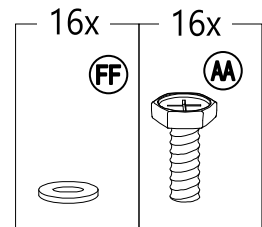
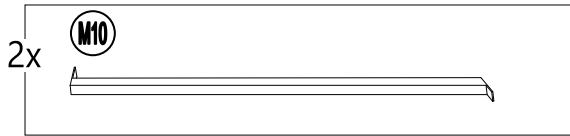
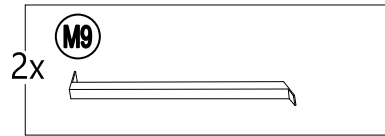
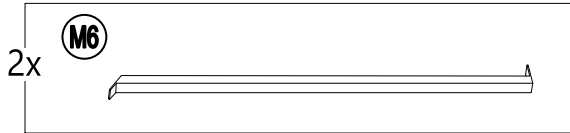
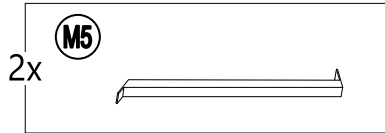

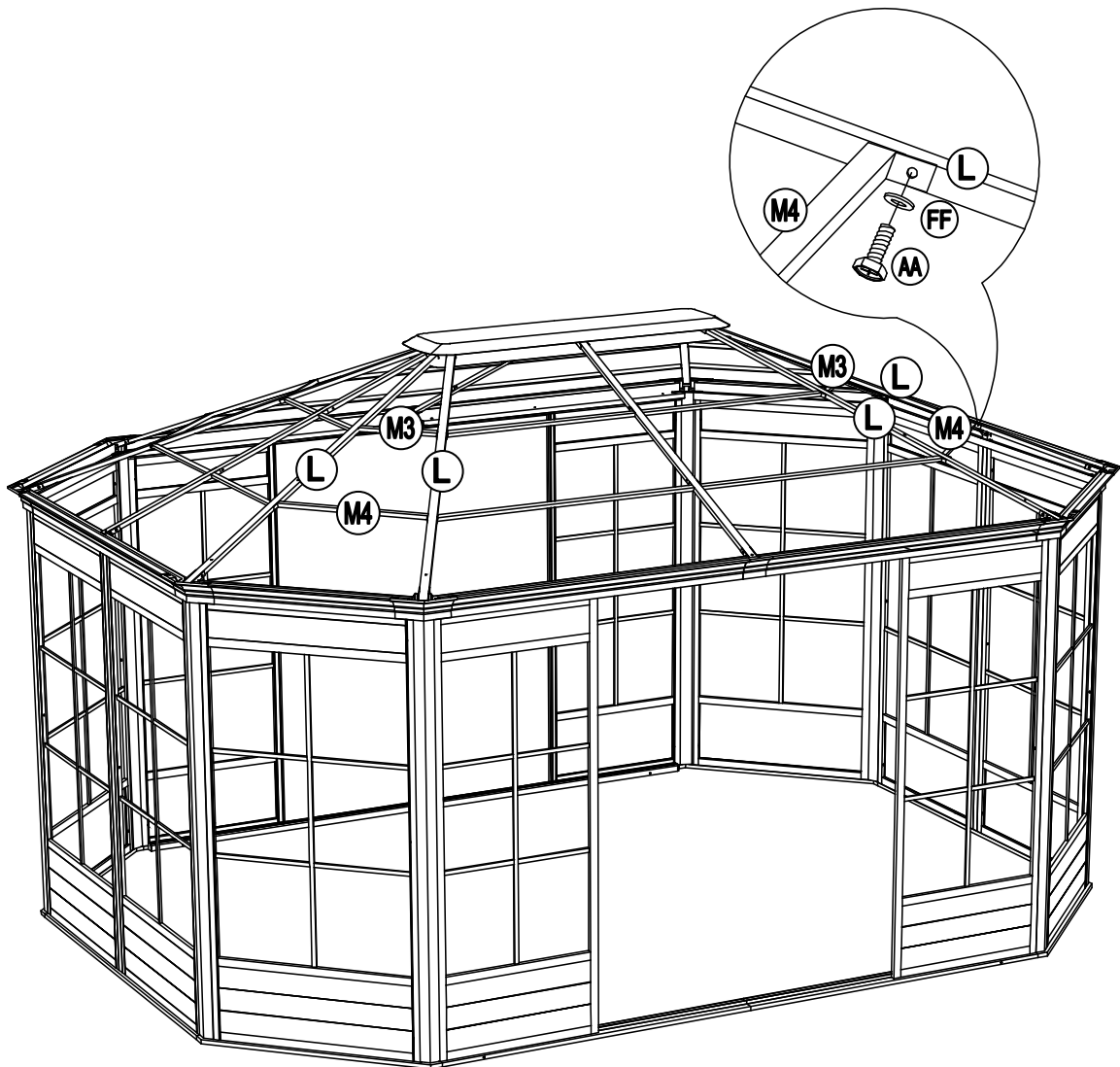
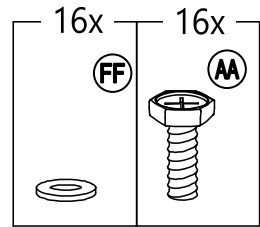
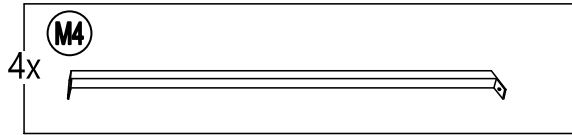
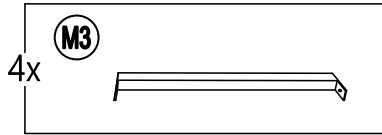

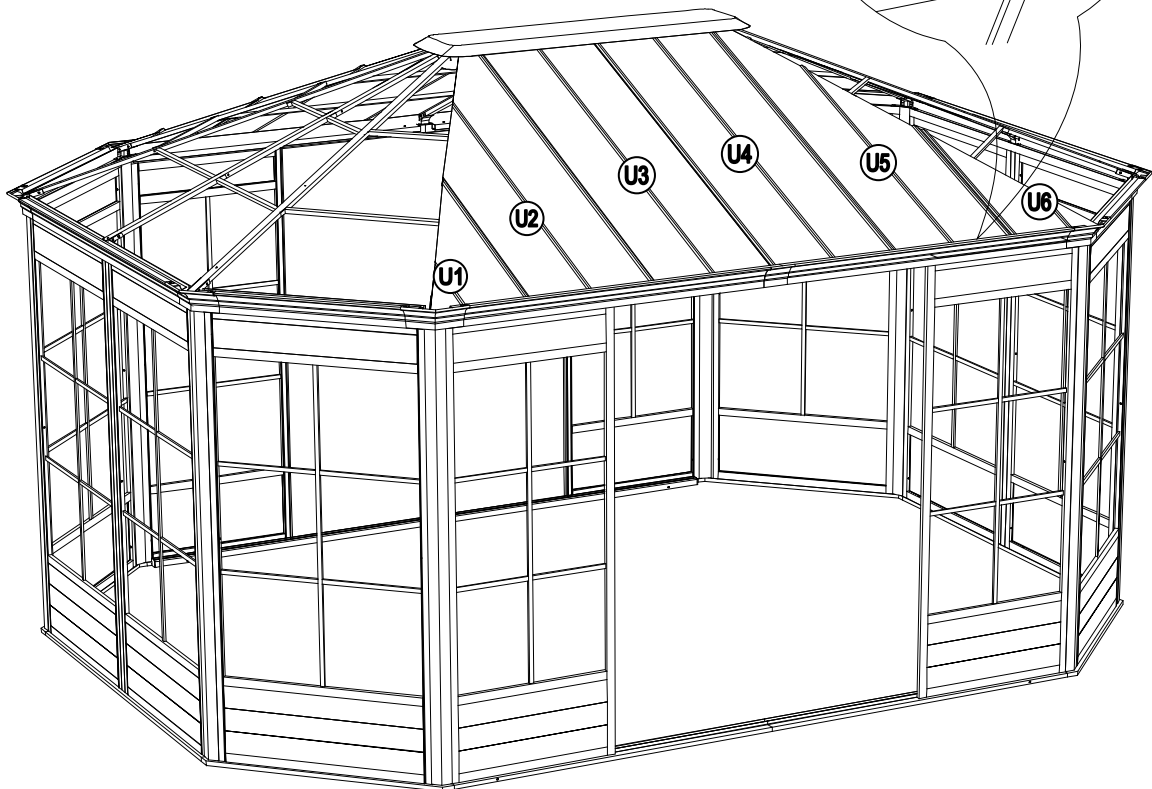
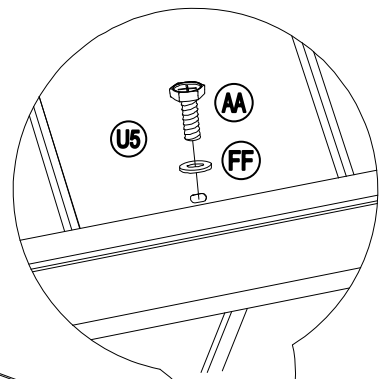
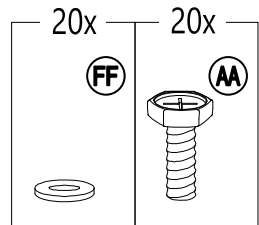
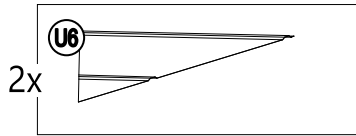
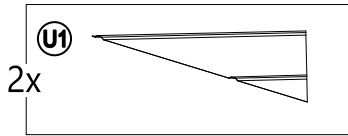
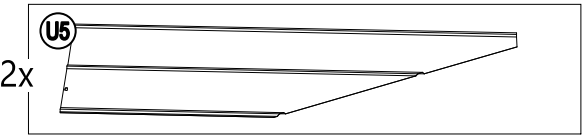
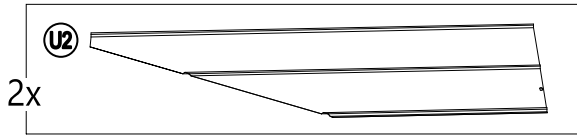

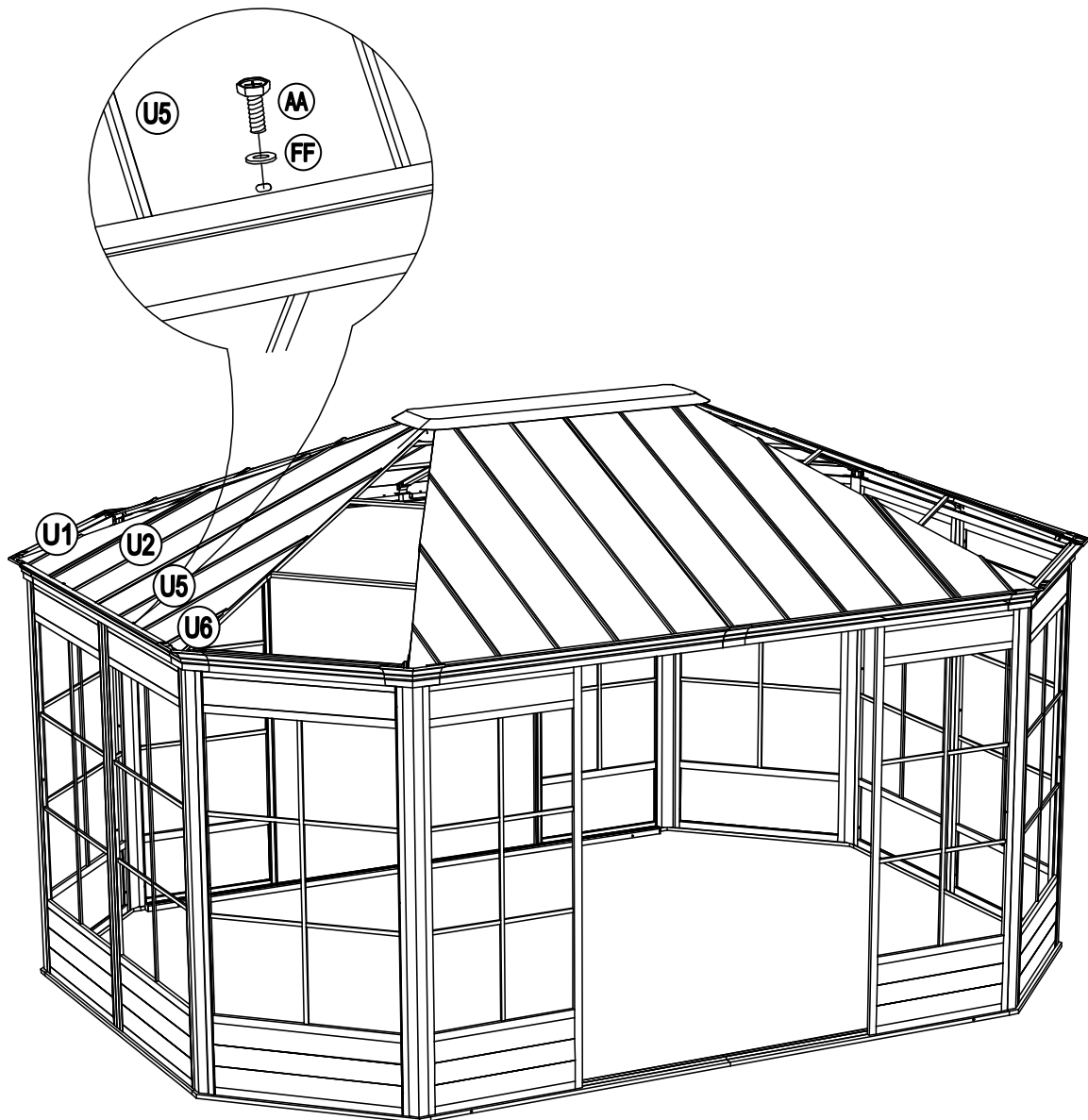
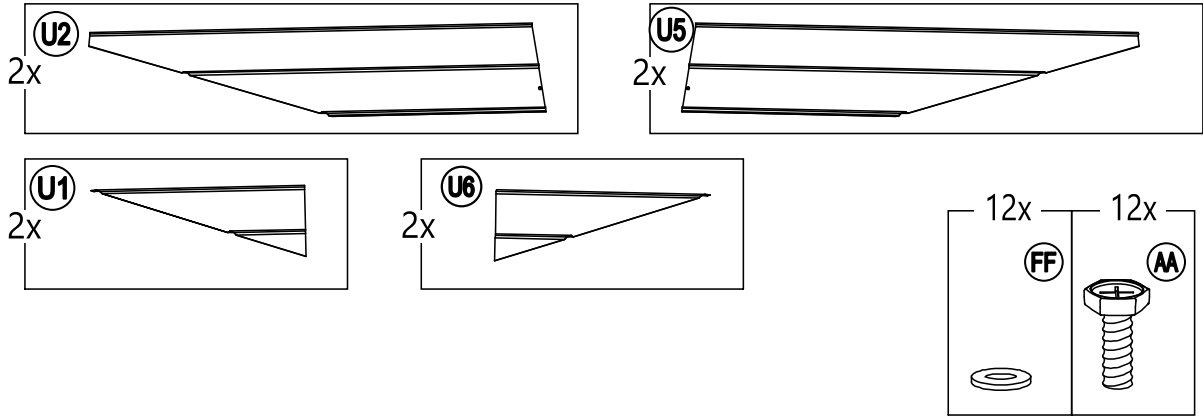

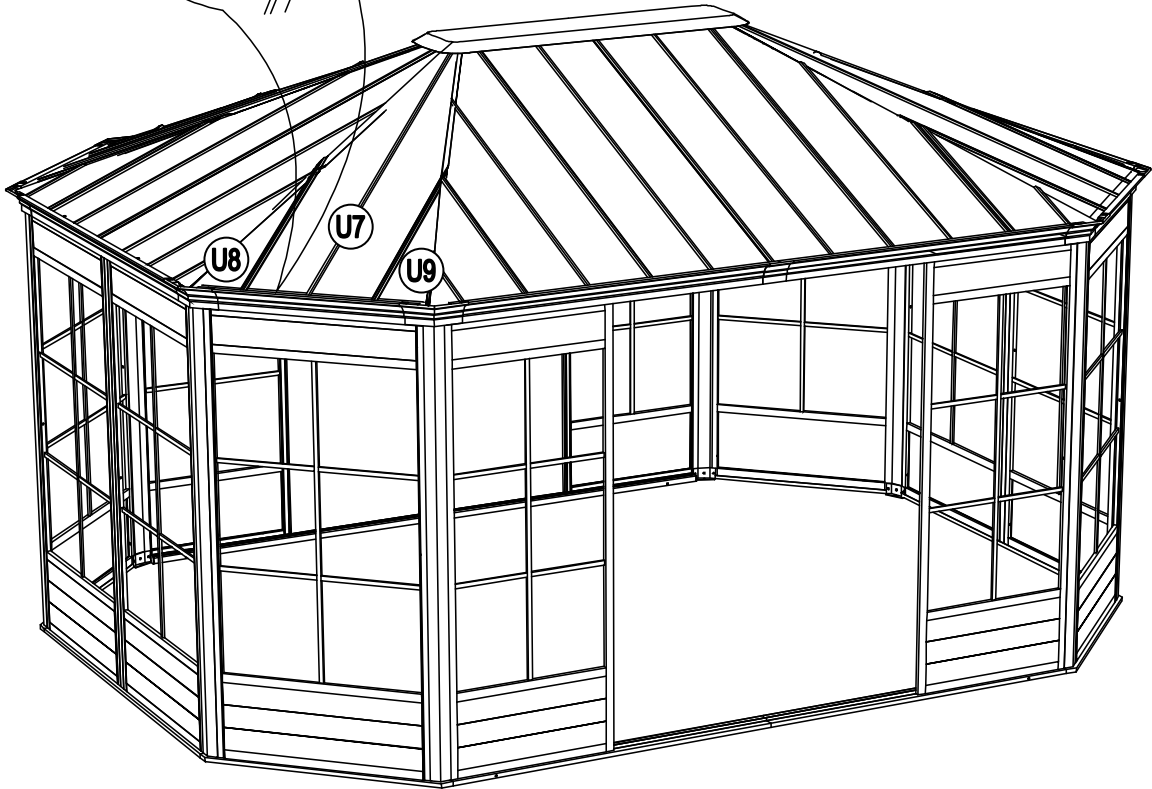
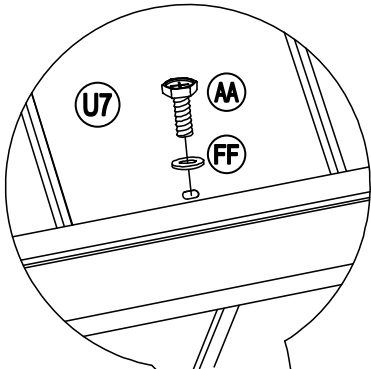
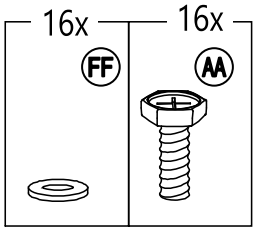
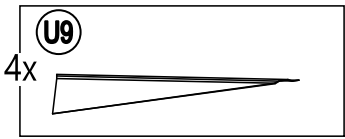
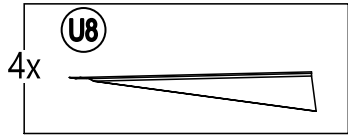
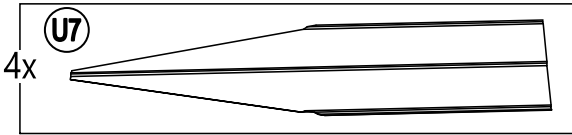

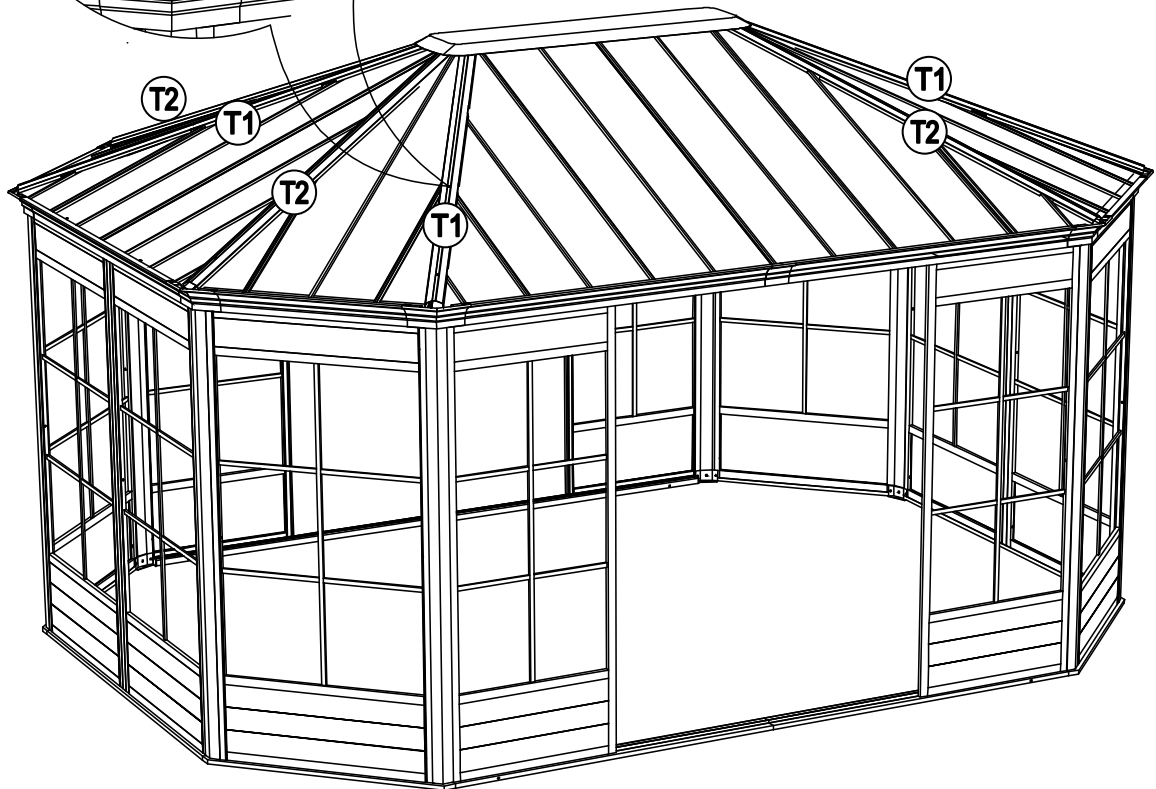
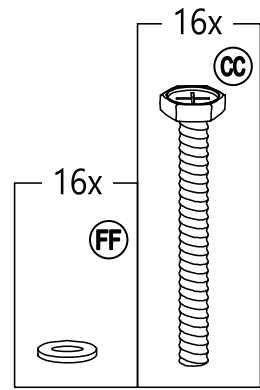
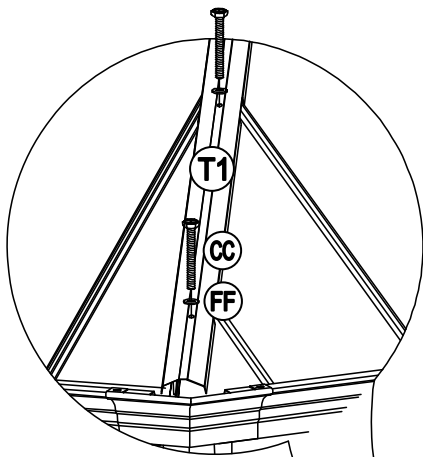
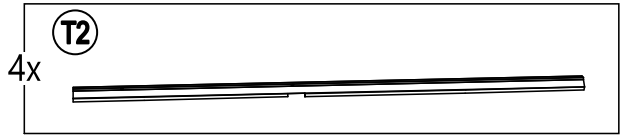
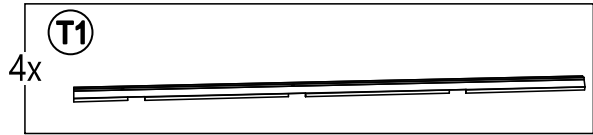

23

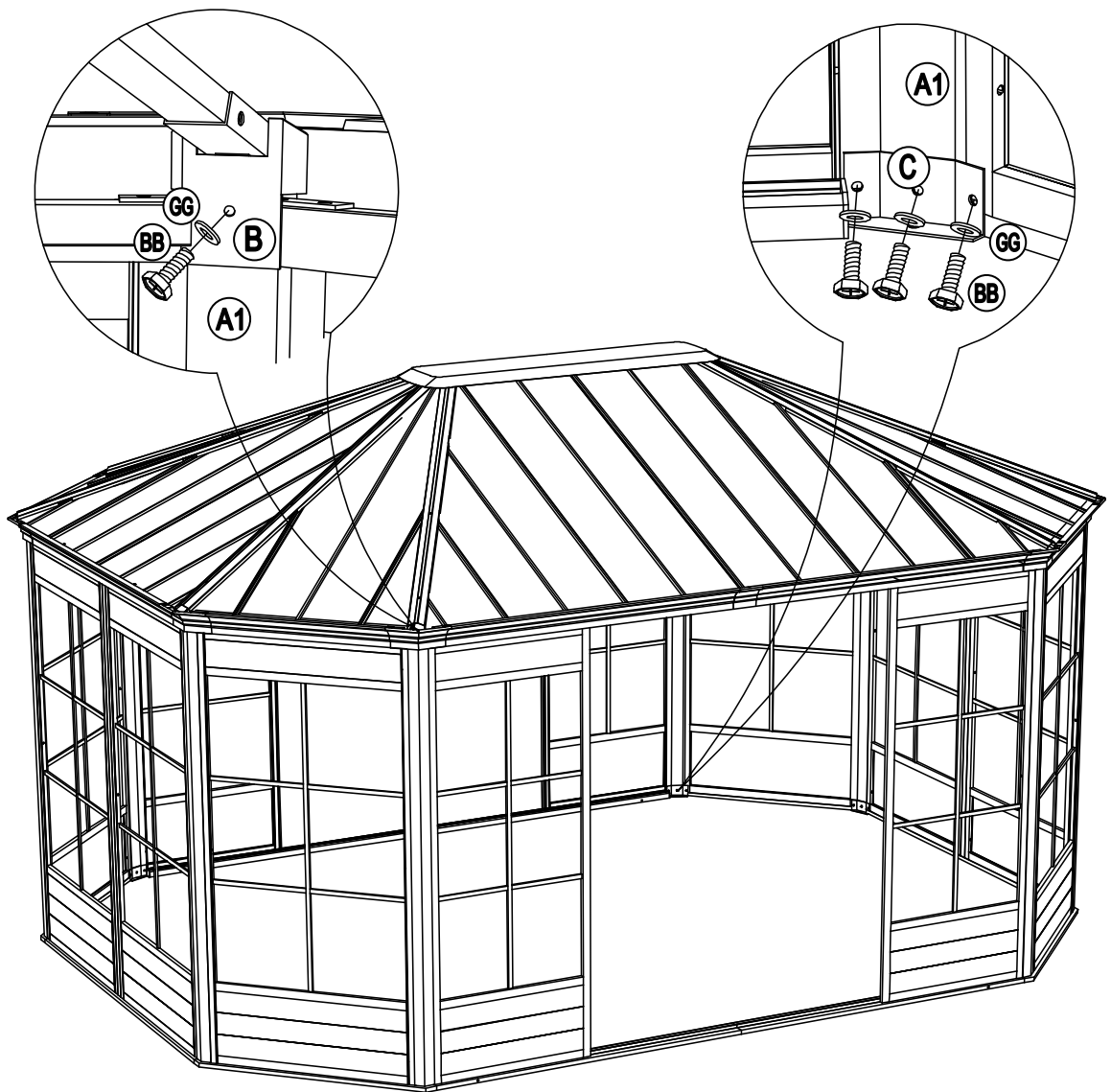
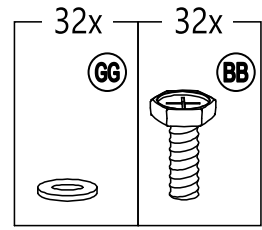
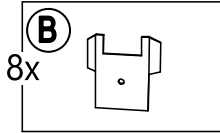
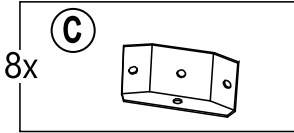

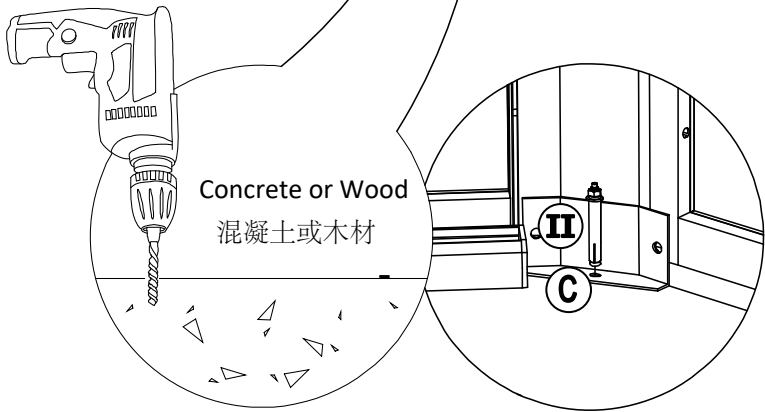
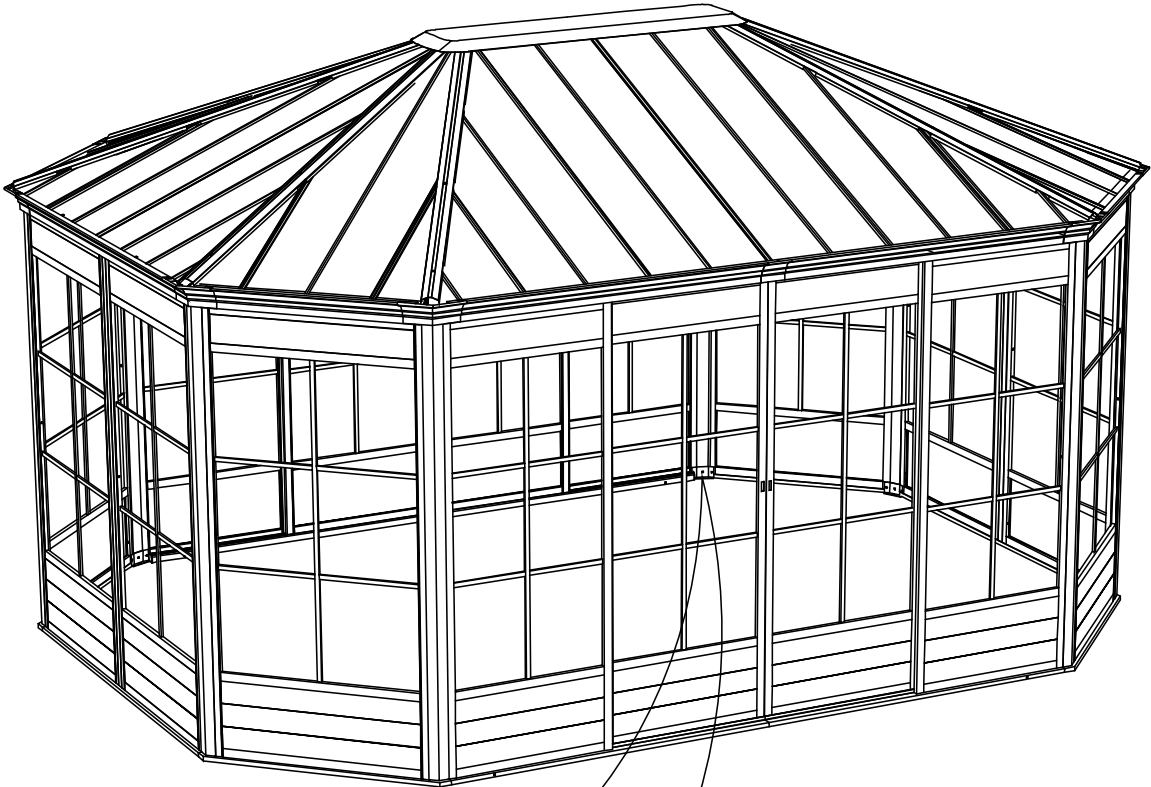
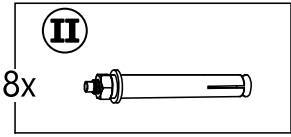

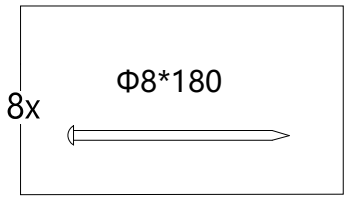

不包含在内
Not Included

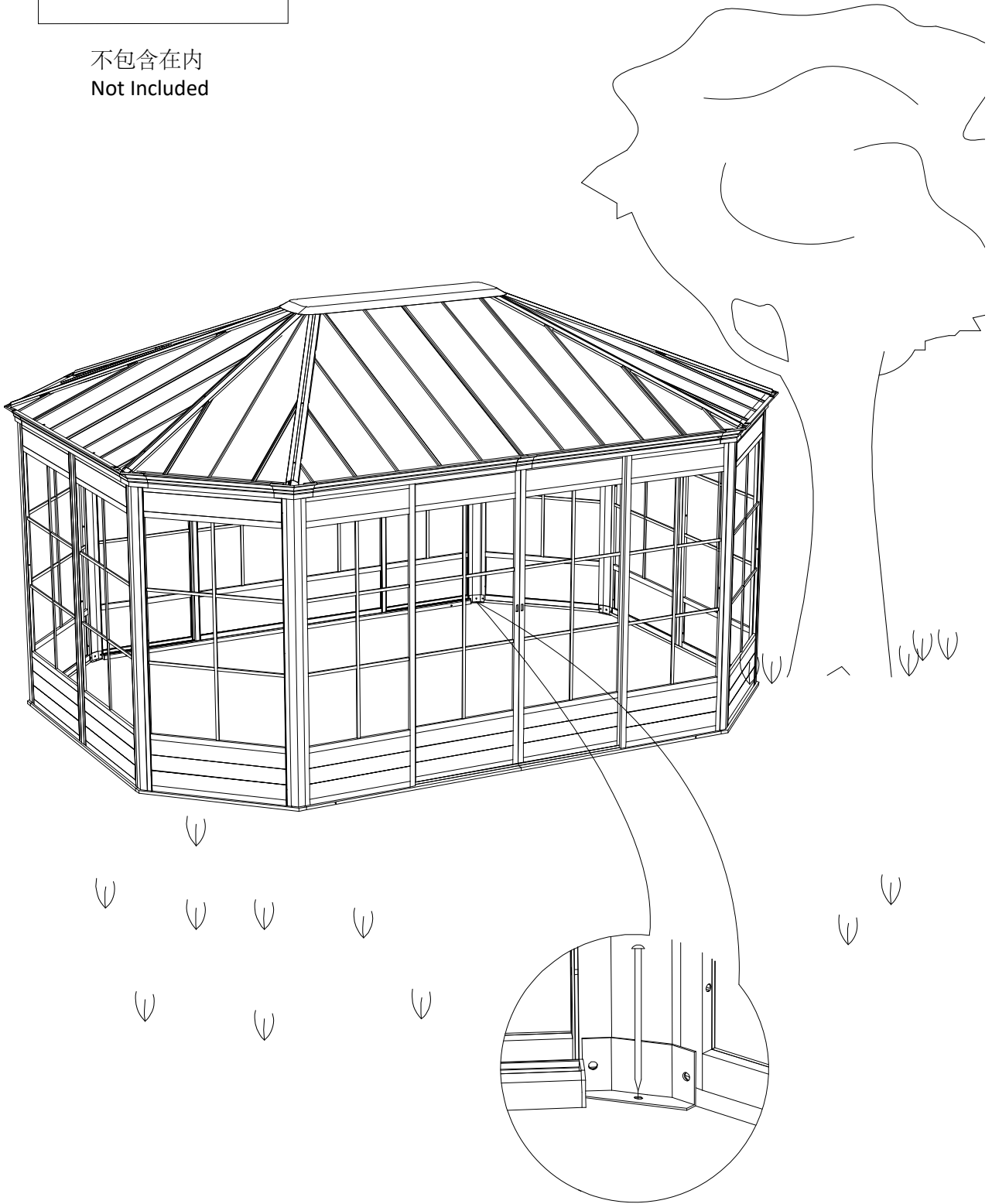

Distributed by:
Costco Wholesale Corporation
P.O. Box 34535
Seattle, WA 98124-1535
USA
1-800-774-2678
www.costco.com

Costco Wholesale Canada Ltd.*
415 W. Hunt Club Road
Ottawa, Ontario
K2E 1C5, Canada
1-800-463-3783
www.costco.ca
* faisant affaire au Québec sous
le nom les Entrepôts Costco

Importado por:
Importadora Primex S.A. de C.V.
Blvd. Magnocentro No. 4
San Fernando La Herradura
Huixquilucan, Estado de México
C.P. 52765
RFC: IPR-930907-S70
(55)-5246-5500
www.costco.com.mx

Costco Wholesale Australia Pty Ltd
17-21 Parramatta Road
Lidcombe NSW 2141
Australia
www.costco.com.au

Costco Wholesale UK Ltd /
Costco Online UK Ltd
Hartspring Lane
Watford, Herts
WD25 8JS
United Kingdom
01923 213113
www.costco.co.uk

Costco Wholesale Spain S.L.U.
Polígono Empresarial Los Gavilanes
C/ Agustín de Betancourt, 17
28906 Getafe (Madrid) España
NIF: B86509460
900 111 155
www.costco.es

Costco Wholesale Iceland ehf.
Kauptún 3-7, 210 Gardabaer
Iceland
www.costco.is

Costco France
1 avenue de Bréhat
91140 Villebon-sur-Yvette
France
01 80 45 01 10
www.costco.fr

Costco Wholesale Japan Ltd.
3-1-4 Ikegami-Shincho
Kawasaki-ku, Kawasaki-shi,
Kanagawa 210-0832 Japan
0570-200-800
www.costco.co.jp

Costco Wholesale Korea, Ltd.
40, Iljik-ro
Gwangmyeong-si
Gyeonggi-do, 14347, Korea
1899-9900
www.costco.co.kr

Costco Wholesale New Zealand Limited
2 Gunton Drive
Westgate
Auckland 0814
New Zealand

Costco (China) Investment Co., Ltd.
Room 1003, Block 2, 2388 Xiupu Road,
Pudong New Area, Shanghai
China 201315
+86-21-6257-7065

Costco Wholesale Sweden AB
Saluvägen 5
187 66 Täby
Sweden

中國製造
MADE IN CHINA

生產編號: 2022200223
Production Number: 2022200223