

DOUBLE-SIDED MOBILE BIN RACK USER'S MANUAL

Please inspect box contents to ensure you have received all components.

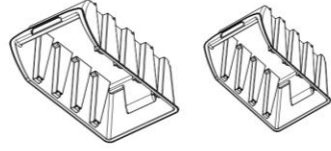

J SMALL BINS - x64
MEDIUM BINS - x30



I BAR SUPPORT SCREWS - x7



H WASHERS - x20



G SCREWS - x20 (larger one)



B TOP SHELF - x1

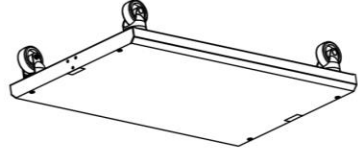

A BOTTOM SHELF - x1
(casters come installed)



F HANGING BAR SUPPORT - x1

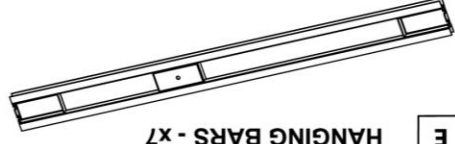

E HANGING BARS - x7

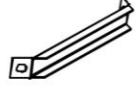

D POSTS SUPPORTS - x4



C POSTS - x2

Trinity 移動式雙面使用收納架 使用者手冊

請檢查包裝內容物以確認所有配件都未遺漏。

A 底架 - 1個 (腳輪已完成安裝)



B 頂架 - 1個

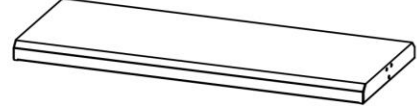

C 桿子 - 2個



G 螺絲 - 20顆 (較大)



D 桿子支撐架 - 4個

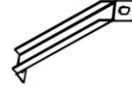

H 墊圈 - 20個



E 懸吊橫桿 - 7個

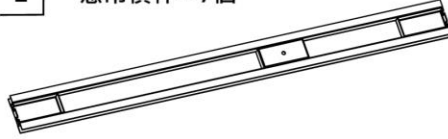

I 橫桿支撐架螺絲 - 7顆



F 懸吊橫桿支撐架 - 1個



J 小型置物盒 - 64個
中型置物盒 - 30個

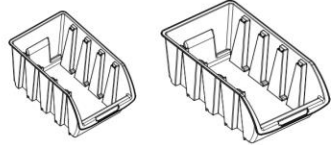

步驟1

兩側的桿子 (C) 裝入底架 (A)。確認螺絲朝內安裝，才能與「向上」的標籤指示相符。將桿子 (C) 上的螺帽與底架 (A) 側邊的孔洞對齊。墊圈 (H) 置於螺絲 (G) 下方並鎖上螺絲。兩邊的桿子 (C) 只需稍微固定。直到組裝完成之前都請勿完全地鎖緊固定。

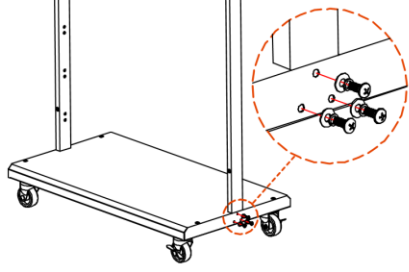

步驟2

以螺絲 (G) 和墊圈 (H) 將桿子 (C) 兩側對角的桿子支撐架 (D) 鎖上固定。各對角的桿子支撐架 (D) 的兩端分別固定於桿子 (C) 及底架 (A) 上。

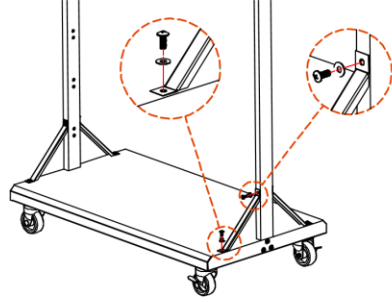

步驟3

將兩側桿子 (C) 內側的螺絲鬆開，以便安裝懸吊橫桿 (E)。從最底部的橫桿開始安裝，所有橫桿安裝的方向需相同。確認遵照標籤「L」及「R」的指示。懸吊橫桿移至定位後再向下固定。再將兩側桿子 (C) 的螺絲重新鎖上。

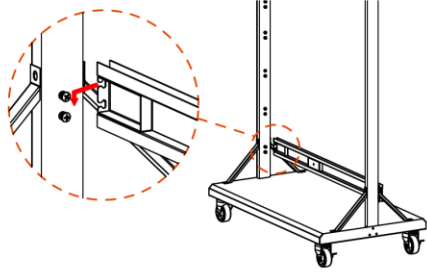

步驟4

將頂架 (B) 移至兩根桿子 (C) 的頂端並以螺絲 (G) 及墊圈 (H) 將兩側鎖緊固定。

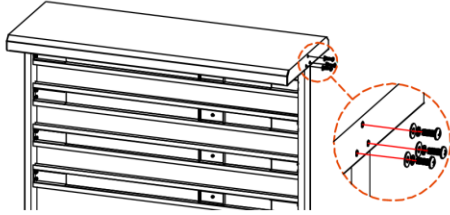

Step 1
Insert both POSTS (C) into the BOTTOM SHELF (A). Make sure that the screws are facing INWARD, and that the "up" sticker is followed. Line up the nuts on the POSTS (C) with the holes on the side of the BOTTOM SHELF (A). Secure with the WASHERS (H) underneath the SCREWS (G). Loosely secure both POSTS (C). Do NOT tighten completely until the end.

Step 2
Secure a diagonal POST SUPPORT (D) to each side of the POSTS (C) with the SCREWS (G) and WASHERS (H). Screw one end of each diagonal POST SUPPORT (D) into the POST (C) and the other end into the BOTTOM SHELF (A).

Step 3
Loosen the screws on the inside of both POSTS (C) so that HANGING BARS (E) can be inserted. Starting with the lowest bar, insert all bars in the same direction. Make sure to follow the "L" and "R" stickers. Slide the HANGING BAR in, and then down. Re-tighten the screws on both POSTS (C).

Step 4
Slide the TOP SHELF (B) onto the top of both POSTS (C) and secure it with the SCREWS (G) and WASHERS (H) on both sides.

步驟5

以橫桿支撐架螺絲 (I) 將懸吊橫桿支撐架 (F) 固定於懸吊橫桿 (E) 上。懸吊橫桿支撐架 (F) 應與懸吊橫桿 (E) 對齊，而U型槽應面朝外。確認遵照「向上」的標籤指示。

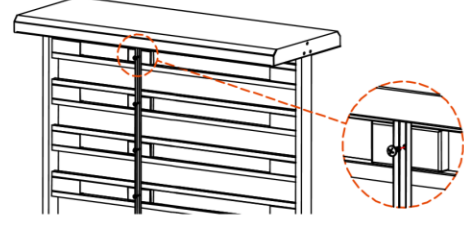

步驟6

以一根拇指由置物盒 (J) 的背內側向下壓，以便將置物盒 (J) 固定就位，確實地向下壓入懸吊橫桿 (E) 直到置物盒的背後邊緣與懸吊橫桿 (E) 頂端固定相接。確認擺放置物盒 (J) 時應成行由底部向上安裝。

最上面4層的懸吊橫桿應擺放小型置物盒，而中型置物盒則須安裝於底部3層的懸吊橫桿上。架子上擺放置物盒之前，請勿於盒子內擺放物品。

Step 5
Attach the HANGING BAR SUPPORT (F) to the HANGING BARS (E) with the BAR SUPPORT SCREWS (I). The HANGING BAR SUPPORT (F) should be flush against the HANGING BAR (E), and the U-shape channel should be facing out. Make sure to follow the "up" stickers.

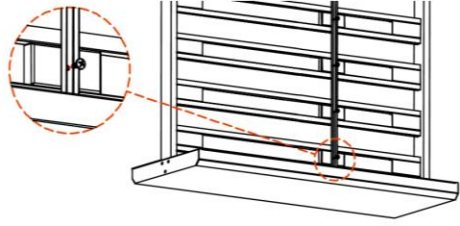

Step 6
Fix the BINS (J) in place by pressing one thumb against the inside back of the BIN (J), and press firmly onto the HANGING BAR (E) until the back lip of the BIN is caught on the top of the HANGING BAR (E). Be sure to place the rows of BINS (J) from the bottom up.

The SMALL BINS belong on the top 4 HANGING BARS, while the MEDIUM BINS belong on the bottom 3 HANGING BARS. **DO NOT LOAD ITEMS INTO BINS BEFORE HANGING ON RACK.**

